



# Vhodno izhodne naprave

Laboratorijska vaja 12

Tipala in signali – praktični izzivi

# Laboratorijska vaja 12

## LV5: Tipala in signali – praktični izzivi

- 12a: LV5a : Tipala in signali – meritve
  - a) Meritev karakteristične upornosti linije z multimetrom ( $R_0$ )
  - b) Preizkusi različnih tipal (IR,UZ razdalja, PIR, Hall, ...)
  - c) Meritve deformacij UTP kabla
  - d) \*LV2-4 - Presluh – meritve na ploščatem kablu
  
- 12b: LV5b : STM32H7 – Generator signalov
  - a) UART                      PB14
  - b) PWM                        PA3
  - c) SPI                         PD3(SCK),            PI3 (MOSI)
  - d) I2C                         PD12(SCL), PD13(SDA)
  - e) CANBUS                    CN1 (FDCAN1: CAN-L, CAN-H)

# Laboratorijska vaja 12

## Tipala in signali – praktični izzivi

### ■ 12a: LV5a : Tipala in signali – meritve

- a) Meritev karakteristične upornosti linije z multimetrom ( $R_0$ )
- b) Preizkusi različnih tipal (IR, UZ razdalja, PIR, Hall, ...)
- c) Meritve deformacij UTP kabla
- d) \*LV2-4 - Presluh – meritve na ploščatem kablu

### ■ 12b: LV5b : STM32H7 – Generator signalov

- a) UART                      PB14
- b) PWM                        PA3
- c) SPI                         PD3(SCK),        PI3 (MOSI)
- d) I2C                         PD12(SCL), PD13(SDA)
- e) CANBUS                    CN1 (FDCAN1: CAN-L, CAN-H)

## LV1\*: Meritev karakteristične upornosti prenosne linije

**izziv:** ali bi lahko z multimetrom in dano opremo lahko določili karakteristično upornost linije ?

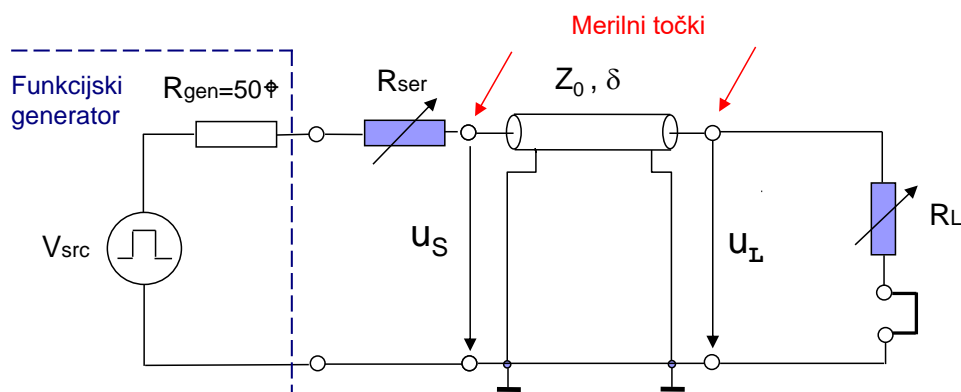

Podan je komplet kablov in opreme z multimetrom. Razmislite ali je mogoče s tem kompletom določiti karakteristično upornost linije in če je mogoče, opišite vse podrobnosti. Sicer utemeljite nasprotni odgovor.



# Laboratorijska vaja 12

## Tipala in signali – praktični izzivi

- 12a: LV5a : Tipala in signali – meritve
  - a) Meritev karakteristične upornosti linije z multimetrom ( $R_0$ )
  - b) Preizkusi različnih tipal (IR, UZ razdalja, PIR, Hall, ...)
  - c) Meritve deformacij UTP kabla
  - d) \*LV2-4 - Presluh – meritve na ploščatem kablu
  
- 12b: LV5b : STM32H7 – Generator signalov
  - a) UART                      PB14
  - b) PWM                        PA3
  - c) SPI                         PD3(SCK),            PI3 (MOSI)
  - d) I2C                         PD12(SCL), PD13(SDA)
  - e) CANBUS                    CN1 (FDCAN1: CAN-L, CAN-H)

# Preizkusi različnih tipal

Tipala: IR, UZ razdalja, PIR, Hall, ...)

**Izziv:** z ustreznimi orodji (osciloskop, generator, ...) preizkusite in opišite delovanje različnih vrst tipal po lastni izbiri.

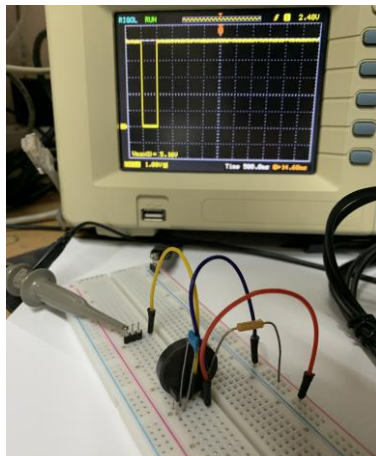

VIN - LV

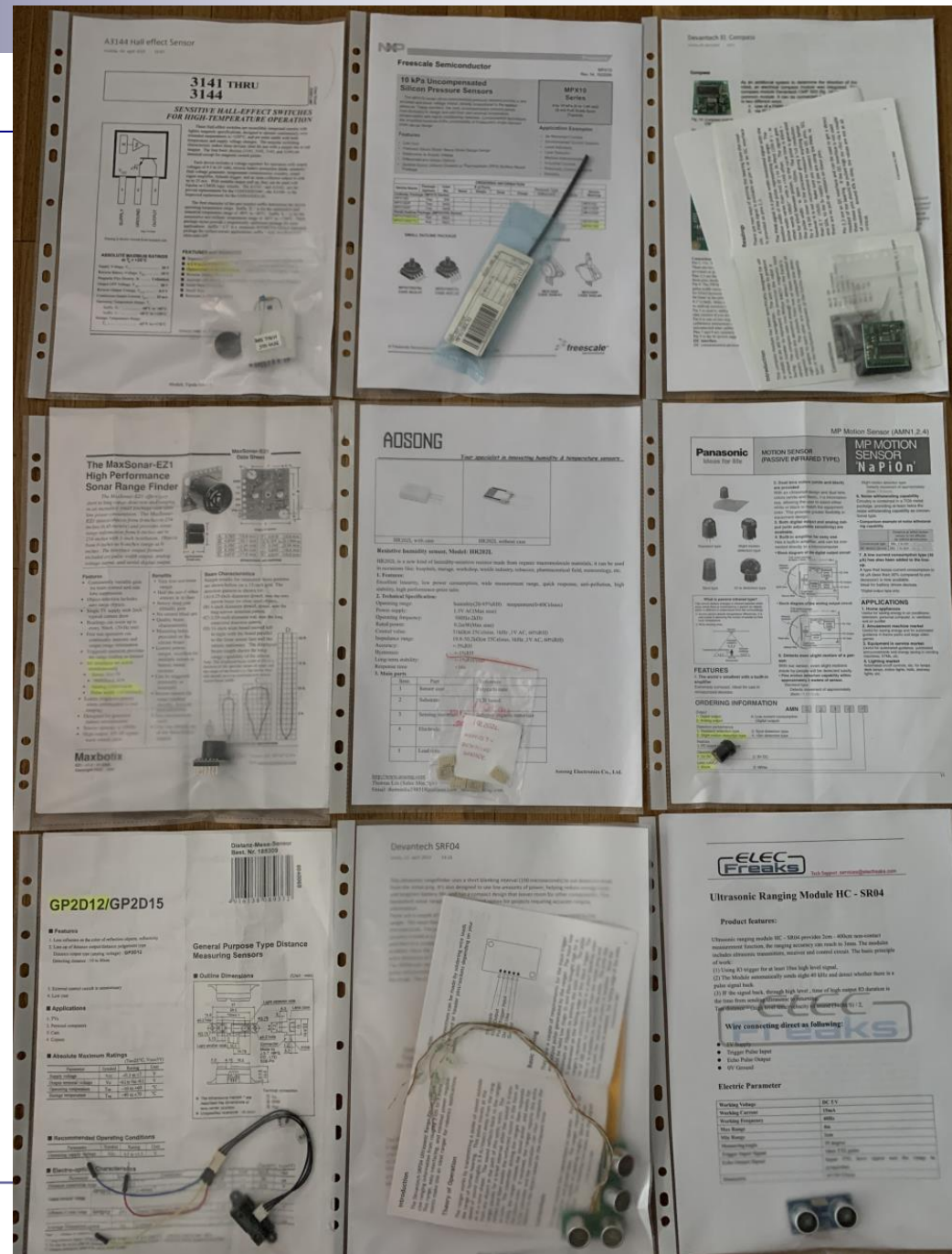

## Preizkusi različnih tipal

Tipala: IR, UZ razdalja, PIR, Hall, ...)

**Izziv:** z ustreznimi orodji (osciloskop, generator, ...) preizkusite in opišite delovanje različnih vrst tipal po lastni izbiri.

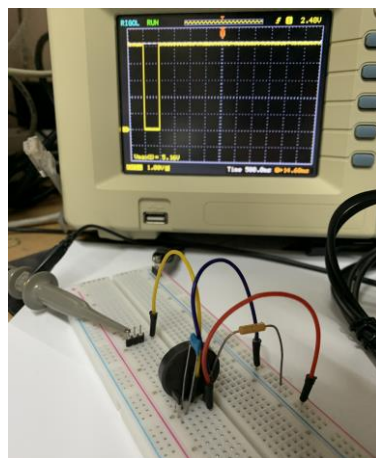

VIN - LV

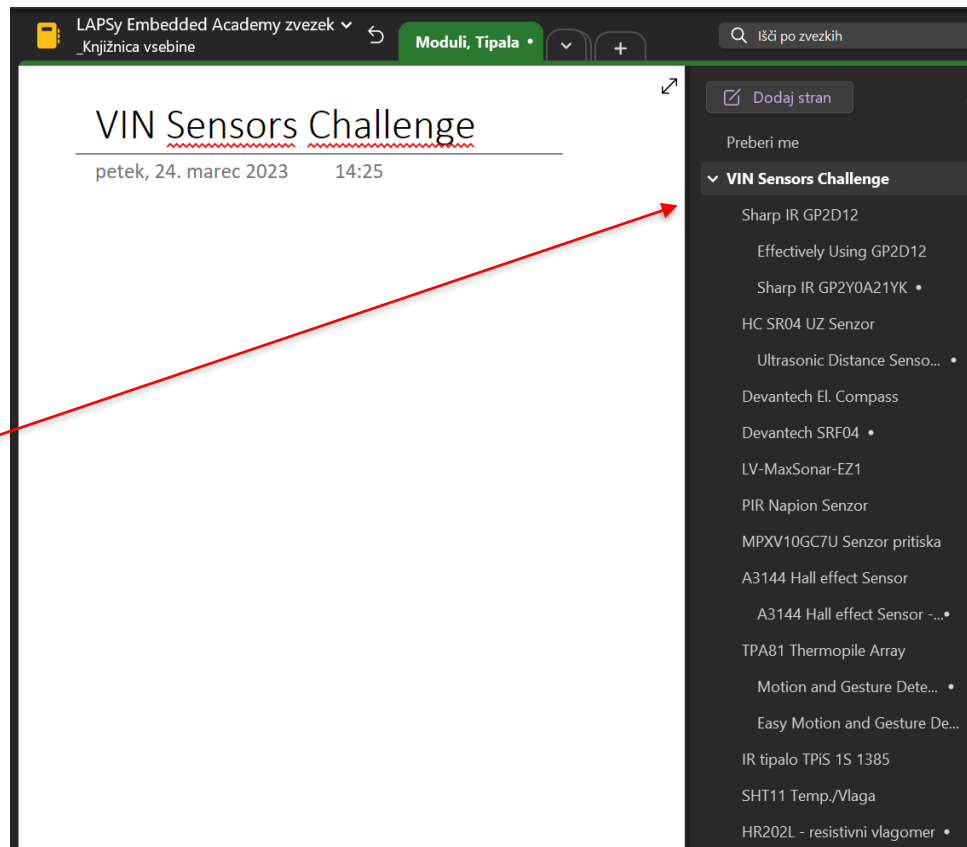

## MB1010 LV-MaxSonar-EZ1

[MB1010 Datasheet](#)

Ranges from 6 inches to 254 inches with a 20Hz read rate. Wide detection field. Excellent for people detection.

Z naslova <<https://maxbotix.com/products/mb1010>>

### Features

- Continuously variable gain for control and side lobe suppression
- Object detection to zero range objects
- 2.5V to 5.5V supply with 2mA typical current draw
- Readings can occur up to every 50mS, (20-Hz rate)
- Free run operation can continually measure and output range information
- Triggered operation provides the range reading as desired
- Interfaces are active simultaneously
- Serial, 0 to Vcc, 9600 Baud, 81N
- Analog, (Vcc/512) / inch
- Pulse width, (147uS/inch)

### Priklop :

- Napajanje
  - 2.5-5.5V
  - GND
- Izhoda:
  - Analogni
  - PWM

## LV-MaxSonar® -EZ™ Series High Performance Sonar Range Finder MB1000, MB1010, MB1020, MB1030, MB1040<sup>2</sup>

With 2.5V - 5.5V power the LV-MaxSonar-EZ provides very short to long-range detection and ranging in a very small package. The LV-MaxSonar-EZ detects objects from 0-inches out to 254-inches (6.45-meters) and provides sonar range information from 6-inches out to 254-inches with 1-inch resolution. Objects from 0-inches to 6-inches typically range as 6-inches'. The interface output formats included are pulse width output, analog voltage output, and RS232 serial output. Factory calibration and testing is completed with a flat object. <sup>1</sup>See Close Range Operation

LV-MaxSonar® -EZ™ Series

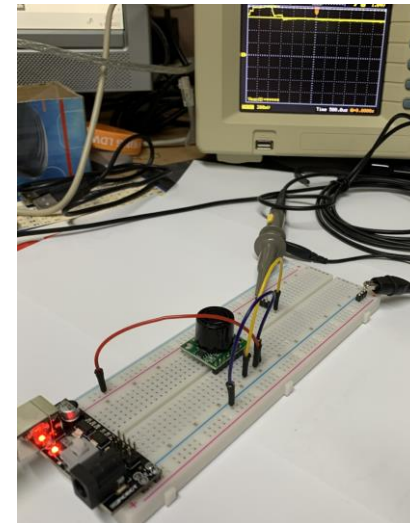
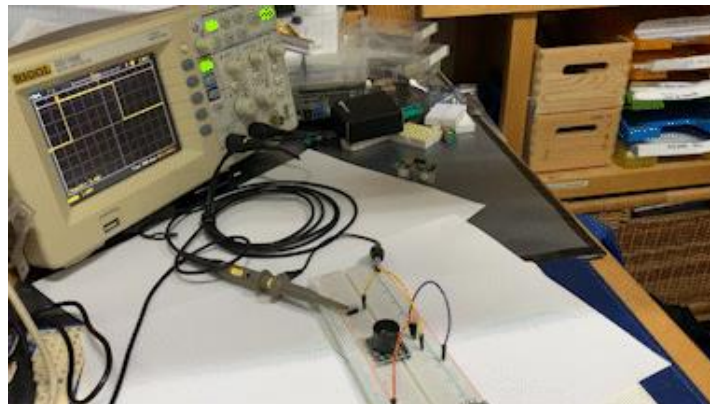
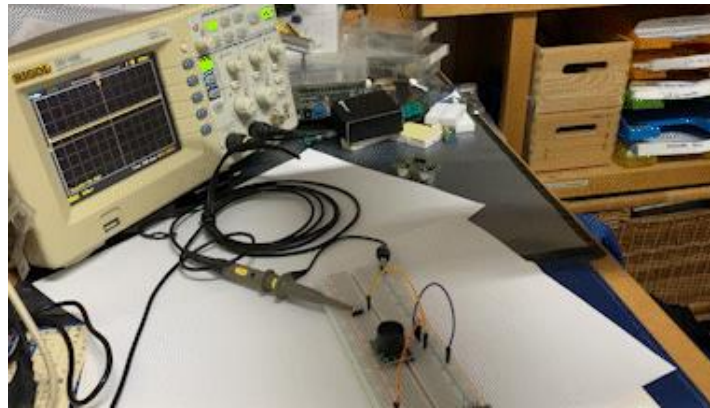



# Preizkusi različnih tipal (IR, UZ razdalja, PIR, Hall, ...)

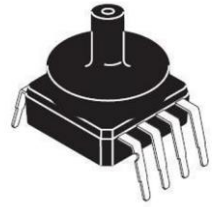

## MPXV10GC7U

Z naslova <<https://eu.mouser.com/ProductDetail/NXP-Semiconductors/MPXV10GC7U?qs=N2XN0KY4UWWYdp78g4P8QQ%3D%3D>>

### 6 Pin Information

#### 6.1 MPXV10GC6U

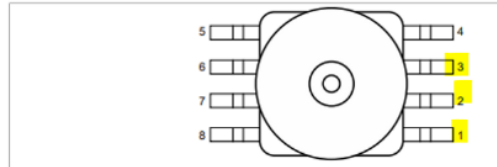

Figure 2. Case 482A-01

Table 2. Pin definitions - MPXV10GC6U

Symbol	Pin	Description
GND	1	Ground
+V <sub>OUT</sub>	2	+Voltage output
V <sub>S</sub>	3	Power supply

### 8 Operating Characteristics

Table 7. Operating Characteristics (V<sub>S</sub> = 3.0 Vdc, T<sub>A</sub> = 25 °C unless otherwise noted, P1 > P2)

Characteristic	Symbol	Min	Typ	Max	Unit
Operating Pressure Range	[1] P <sub>OP</sub>	0	—	10	kPa
Supply Voltage	[2] V <sub>S</sub>	—	3.0	6.0	V <sub>DC</sub>
Supply Current	I <sub>o</sub>	—	6.0	—	mAdc
Full Scale Span	[3] V <sub>FSS</sub>	20	35	50	mV
Offset	[4] V <sub>off</sub>	0	20	35	mV
Sensitivity	ΔV/ΔP	—	3.5	—	mV/kPa

#### Priklop :

- Napajanje
  - Do 6V
  - GND
- Izhod:
  - Analogni

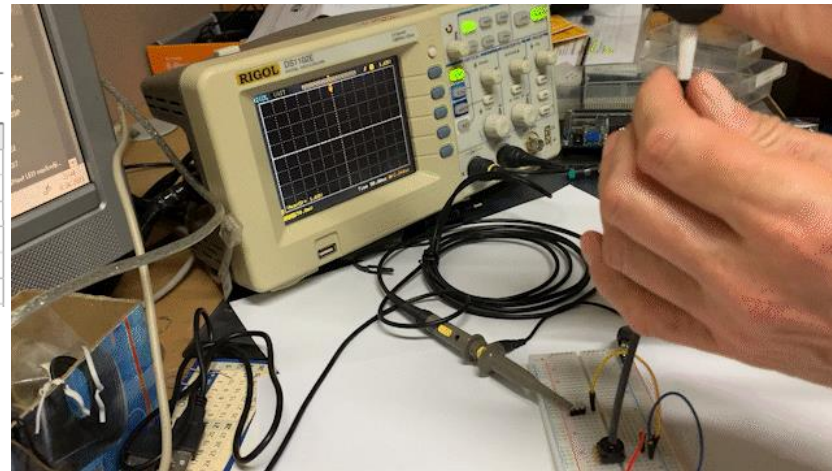
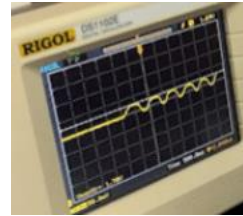
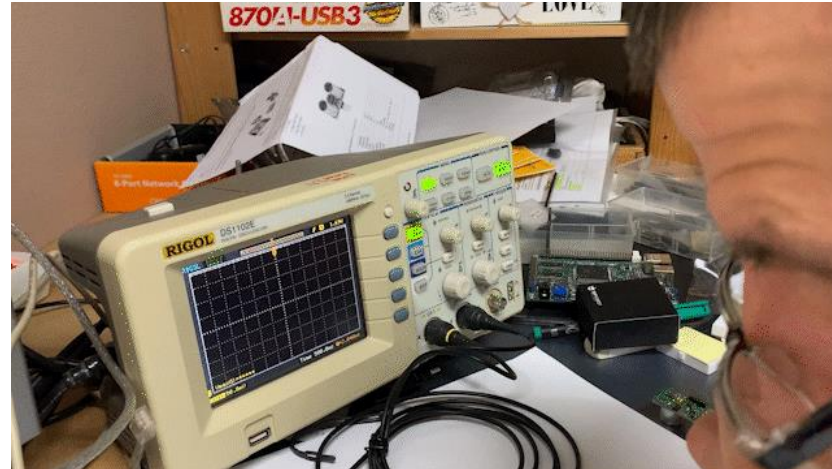

# Preizkusi različnih tipal (IR, UZ razdalja, PIR, Hall, ...)

## 2. Slight motion detection type

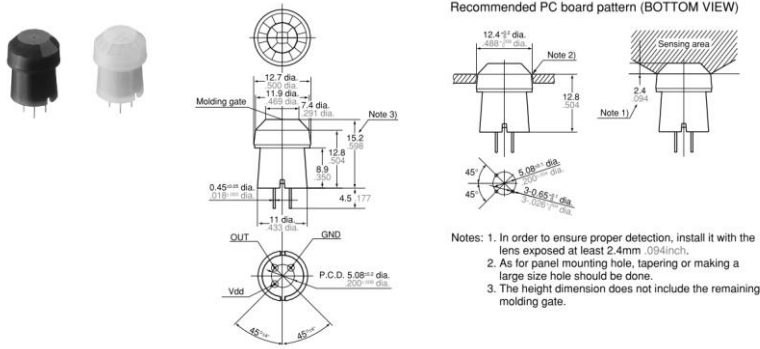

### Priklop :

- Napajanje
  - 3-6V
  - GND
- Izhod:
  - Digitalni (H/L)

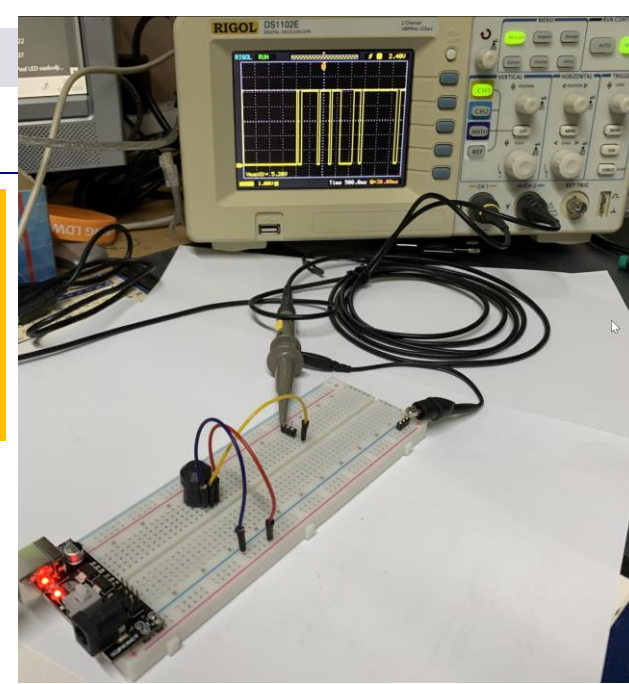

## 3. Electrical characteristics (Measuring condition: ambient temp. = 25°C 77°F; operating voltage = 5V) (Common to All types)

### 1) Digital output

Items	Symbol	Specified value		Measured conditions
		Standard type	Low current consumption type	
Reted operating voltage	Minimum	3.0 V DC	2.2 V DC	
	Typical Maximum	6.0 V DC	3.0 V DC	
Reted consumption current (Standby) *Remark	Typical	170 μA	46 μA	Iout = 0
	Maximum	300 μA	60 μA	
Output (when detecting)	Current	100 μA	100 μA	Vout ≥ Vdd-0.5
	Voltage	Minimum Maximum	Vdd -0.5	
Circuit stability time	Typical	7 s	7 s	
	Maximum	30 s	30 s	

Remark: The current which is consumed during detection consists of the standby consumed current plus the output current.

### 2) Analog output

Items	Symbol	Specified value	Measured conditions
Reted operating voltage	Minimum Maximum	4.5 V DC 5.5 V DC	
	Reted consumption current	Typical Maximum	
Output current	Maximum	50 μA	
Output voltage	Minimum Typical Maximum	0 V 2.5 V Vdd	
	Output offset average voltage	Minimum Typical Maximum	
Steady-state noise	Typical Maximum	130 m Vp-p 300 m Vp-p	
	Circuit stability time	Maximum	

Note: To set to the same detection performance as the digital type, set the output voltage to the offset voltage (2.5V) ±0.45V (i.e. 2.95V or more and 2.05V or less).

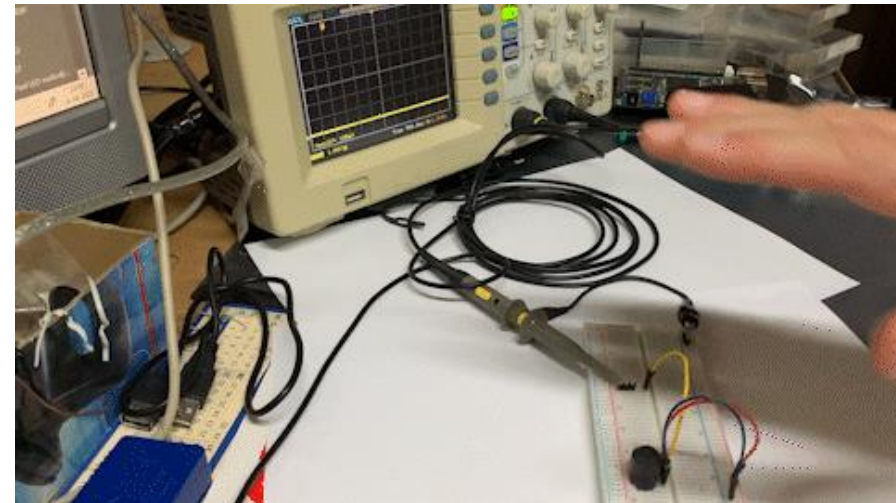

Z naslova <<https://eu.mouser.com/ProductDetail/Panasonic-Industrial-Devices/AMN22111?qs=mTeSeKeuVA4zSZ1O6%2F0inQ%3D%3D>>

[https://eu.mouser.com/datasheet/2/315/panasonic\\_amn1\\_2\\_4-1196943.pdf](https://eu.mouser.com/datasheet/2/315/panasonic_amn1_2_4-1196943.pdf)

# CMPS03 - Compass Module

For documentation on CMPS03 revisions prior to Rev14, [click here](#)

Earlier versions can be identified by the presence of the silver 8MHz ceramic resonator in the middle of the PCB, this has been removed on new modules.

Rev14 was released March 2007

Z naslova <<http://www.robot-electronics.co.uk/hm/cmeps3tech.htm>>

- Priklop :
- Napajanje
    - 5V Pin1
    - GND Pin9
  - Izhod - PWM: Pin4
    - 0-360° (1-37ms)

North ←



- Pin 9 - 0v Ground
- Pin 8 - No Connect
- Pin 7 - No Connect
- Pin 6 - Calibrate
- Pin 5 - Calibrating
- Pin 4 - PWM
- Pin 3 - SDA
- Pin 2 - SCL
- Pin 1 - +5v

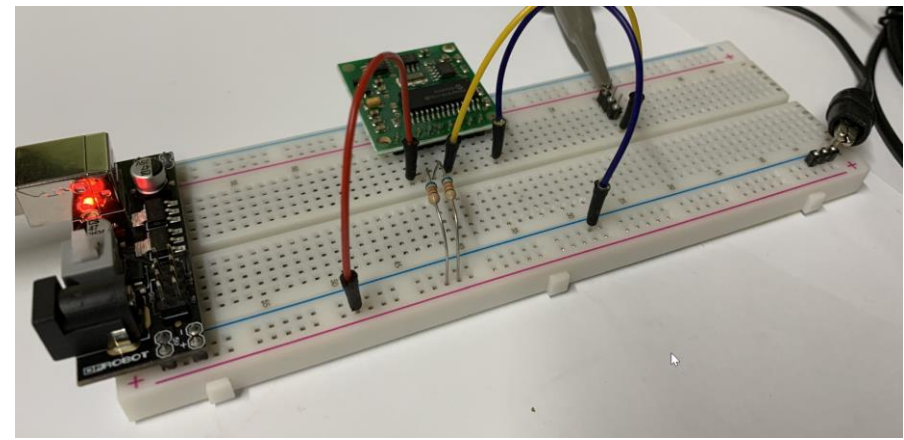

## Connections

Pins 2,3 are the I2C interface and can be used to get a direct readout of the bearing. If the I2C interface is not used then these pins should be pulled high (to +5v) via a couple of resistors. Around 47k is ok, the values are not at all critical.

Pin 4. The PWM signal is a pulse width modulated signal with the positive width of the pulse representing the angle. The pulse width varies from 1mS (0°) to 36.99mS (359.9°) – in other words 100uS/° with a +1mS offset.

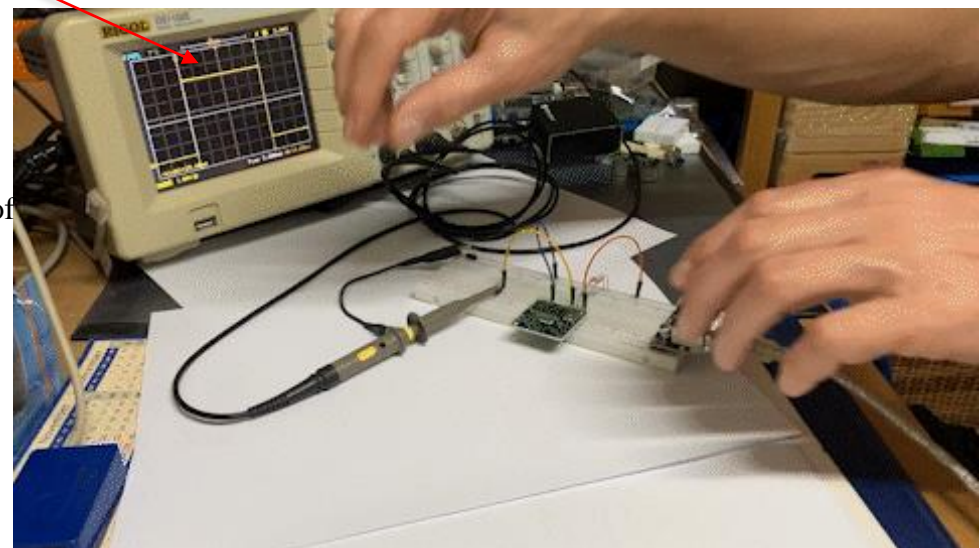

PARAMETER	SYMBOL	CONDITIONS	MIN.	TYP.	MAX.	UNIT
Measuring Distance Range	$\Delta L$		10	-	80	cm
Output Voltage	$V_O$	L = 80 cm	0.25	0.4	0.55	V
Output Voltage Difference	$\Delta V_O$	Output change at L change (80 cm - 10 cm)	1.75	2.0	2.25	V

## Preizkusi različnih tipal (IR, UZ razdalja, PIR, Hall, ...)

**SHARP**

### GP2D12 Optoelectronic Device

#### FEATURES

- Analog output
- Effective Range: **10 to 80 cm**
- LED pulse cycle duration: 32 ms
- Typical response time: 39 ms
- Typical start up delay: 44 ms
- Average current consumption: **33 mA**
- Detection area diameter @ 80 cm: 6 cm

#### DESCRIPTION

The GP2D12 is a distance measuring sensor with integrated signal processing and analog voltage output.

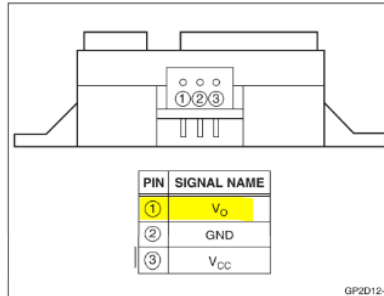

Figure 1. Pinout

**SHARP**

GP2

#### ELECTRICAL SPECIFICATIONS

##### Absolute Maximum Ratings

$T_a = 25^\circ\text{C}$ ,  $V_{CC} = 5\text{ VDC}$

PARAMETER	SYMBOL	RATING	UNIT
Supply Voltage	$V_{CC}$	-0.3 to +7.0	V
Output Terminal Voltage	$V_O$	-0.3 to ( $V_{CC} + 0.3$ )	V
Operating Temperature	$T_{opr}$	-10 to +60	$^\circ\text{C}$
Storage Temperature	$T_{stg}$	-40 to +70	$^\circ\text{C}$

#### Priklop :

- Napajanje
  - Do 7V
  - GND
- Izhod:
  - Analogni

##### Operating Supply Voltage

PARAMETER	SYMBOL	RATING	UNIT
Operating Supply Voltage	$V_{CC}$	4.5 to 5.5	V

##### Electro-optical Characteristics

$T_a = 25^\circ\text{C}$ ,  $V_{CC} = 5\text{ VDC}$

PARAMETER	SYMBOL	CONDITIONS	MIN.	TYP.	MAX.	UNIT	NOTES
Measuring Distance Range	$\Delta L$		10	-	80	cm	1, 2
Output Voltage	$V_O$	L = 80 cm	0.25	0.4	0.55	V	1, 2
Output Voltage Difference	$\Delta V_O$	Output change at L change (80 cm - 10 cm)	1.75	2.0	2.25	V	1, 2
Average Supply Current	$I_{CC}$	L = 80 cm	-	33	50	mA	1, 2

#### NOTES:

1. Measurements made with Kodak R-27 Gray Card, using the white side, (90% reflectivity).
2. L = Distance to reflective object.

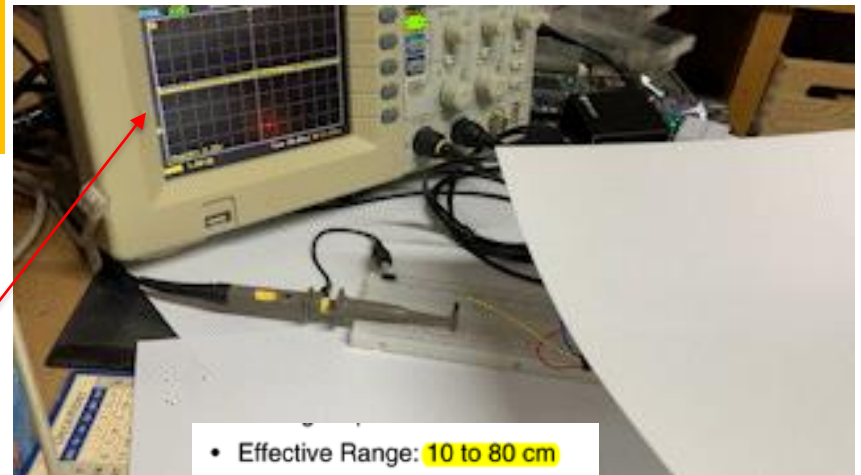
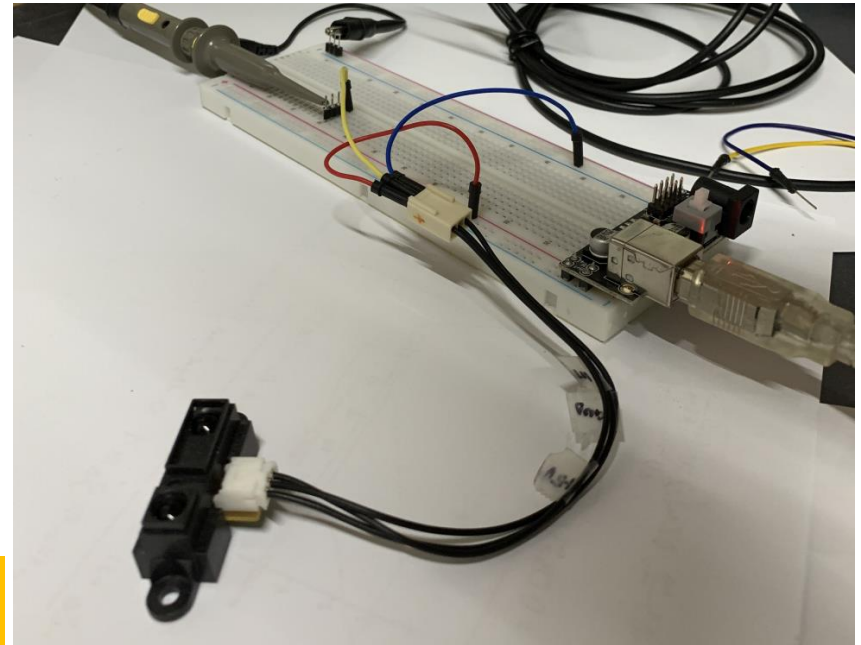

• Effective Range: **10 to 80 cm**

- Priklop :
- Napajanje
    - 4.5-24V
    - GND
  - Izhod OC – „Open Collector“:
    - Digitalni (OC)
    - (10k Pull-up upor)

# 3141 THRU 3144

Data Sheet  
27621.6B\*

## SENSITIVE HALL-EFFECT SWITCHES FOR HIGH-TEMPERATURE OPERATION

These Hall-effect switches are monolithic integrated circuits with tighter magnetic specifications, designed to operate continuously over extended temperatures to +150°C, and are more stable with both temperature and supply voltage changes. The unipolar switching characteristic makes these devices ideal for use with a simple bar or rod magnet. The four basic devices (3141, 3142, 3143, and 3144) are identical except for magnetic switch points.

Each device includes a voltage regulator for operation with supply voltages of 4.5 to 24 volts, reverse battery protection diode, quadratic Hall-voltage generator, temperature compensation circuitry, small-signal amplifier, Schmitt trigger, and an open-collector output to sink up to 25 mA. With suitable output pull up, they can be used with bipolar or CMOS logic circuits. The A3141- and A3142- are improved replacements for the UGN/UGS3140-; the A3144- is the improved replacement for the UGN/UGS3120-.

The first character of the part number suffix determines the device operating temperature range. Suffix 'E-' is for the automotive and industrial temperature range of -40°C to +85°C. Suffix 'L-' is for the automotive and military temperature range of -40°C to +150°C. Three package styles provide a magnetically optimized package for most applications. Suffix '-LT' is a miniature SOT89/TO-243AA transistor package for surface-mount applications; suffix '-UA' is a three-lead ultra-mini-SIP.

### FEATURES and BENEFITS

- Superior Temp. Stability for Automotive or Industrial Applications
- **4.5 V to 24 V Operation** ... Needs Only An Unregulated Supply
- **Open-Collector 25 mA Output** ... Compatible with Digital Logic
- Reverse Battery Protection
- Activate with Small, Commercially Available Permanent Magnets
- Solid-State Reliability
- Small Size
- Resistant to Physical Stress

Always order by complete part number, e.g., **A3141ELT**.

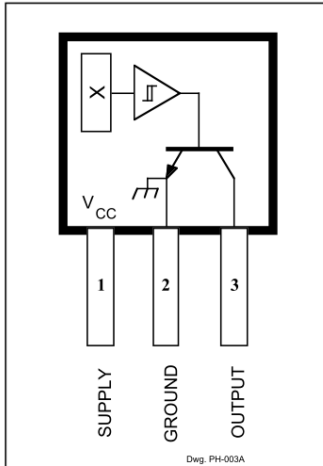
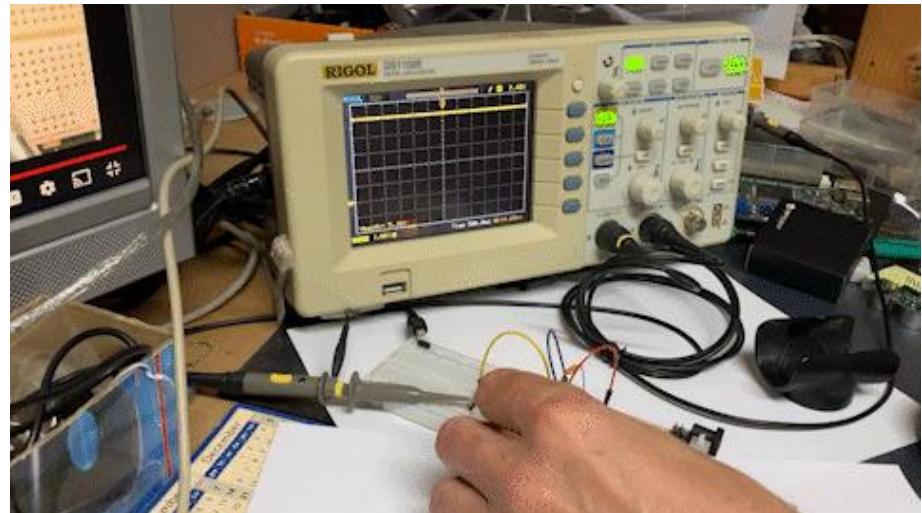
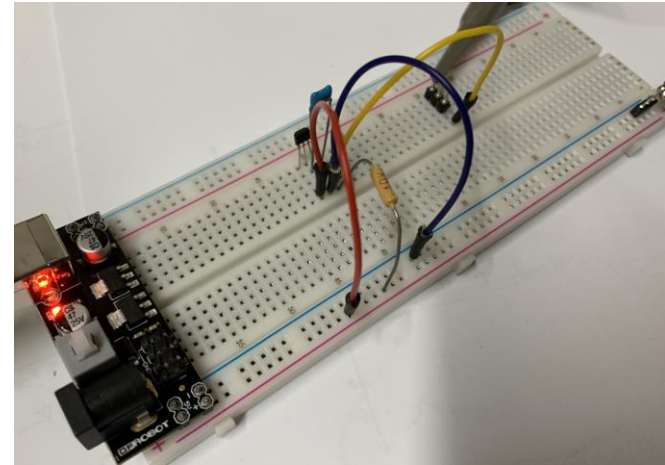

Pinning is shown viewed from branded side.

### ABSOLUTE MAXIMUM RATINGS at T<sub>A</sub> = +25°C

Supply Voltage, V <sub>CC</sub> .....	28 V
Reverse Battery Voltage, V <sub>RCC</sub> .....	-35 V
Magnetic Flux Density, B .....	Unlimited
Output OFF Voltage, V <sub>OUT</sub> .....	28 V
Reverse Output Voltage, V <sub>OUT</sub> .....	-0.5 V
Continuous Output Current, I <sub>OUT</sub> .....	25 mA
Operating Temperature Range, T <sub>A</sub>	
Suffix 'E-' .....	-40°C to +85°C
Suffix 'L-' .....	-40°C to +150°C
Storage Temperature Range,	
T <sub>s</sub> .....	-65°C to +170°C

# Laboratorijska vaja 12

## Tipala in signali – praktični izzivi

- 12a: LV5a : Tipala in signali – meritve
  - a) Meritev karakteristične upornosti linije z multimetrom ( $R_0$ )
  - b) Preizkusi različnih tipal (IR,UZ razdalja, PIR, Hall, ...)
  - c) Meritve deformacij UTP kabla
  - d) \*LV2-4 - Presluh – meritve na ploščatem kablu
  
- 12b: LV5b : STM32H7 – Generator signalov
  - a) UART                      PB14
  - b) PWM                        PA3
  - c) SPI                         PD3(SCK),        PI3 (MOSI)
  - d) I2C                         PD12(SCL), PD13(SDA)
  - e) CANBUS                    CN1 (FDCAN1: CAN-L, CAN-H)

# LV 2\*: Meritve deformacij UTP kabla

**Izziv:** z ustreznimi orodji (osciloskop, generator, ...) določite deformacije (vrsta, razdalja od točke A) na vseh paricah v UTP kablu.

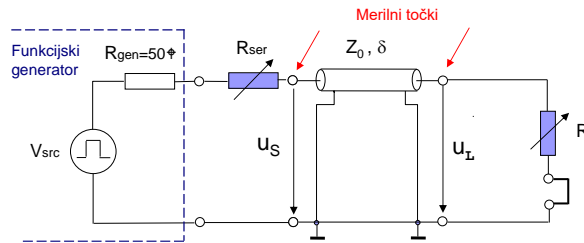
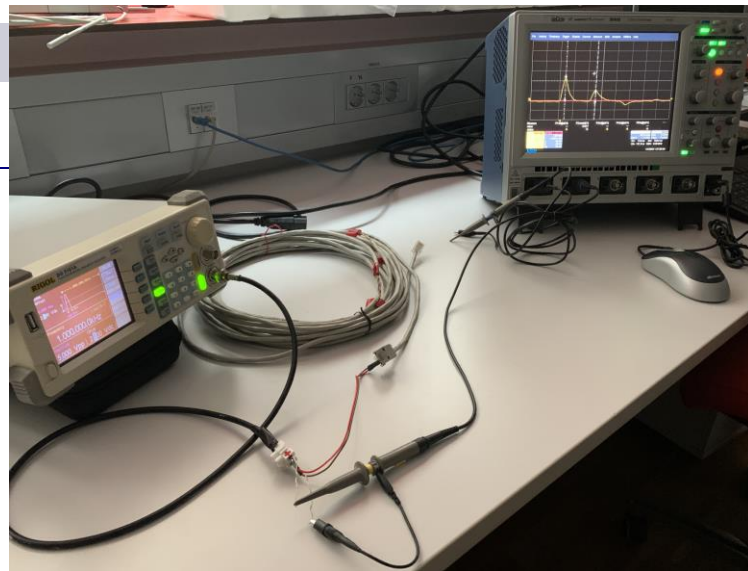

Meritve s pravokotnim signalom, kot pri  $R_0$ :  
trajanje stopničk =  $2\tau$

Meritve s kratkim impulzom:  
zakasnitev odboja impulza =  $2\tau$

odboj v - ... kratki stik

odboj v + ... prekinitev

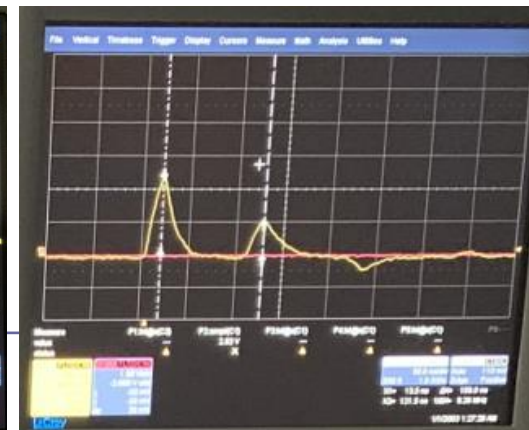
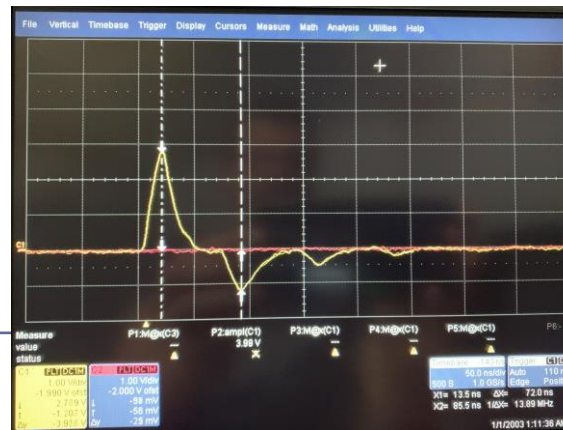
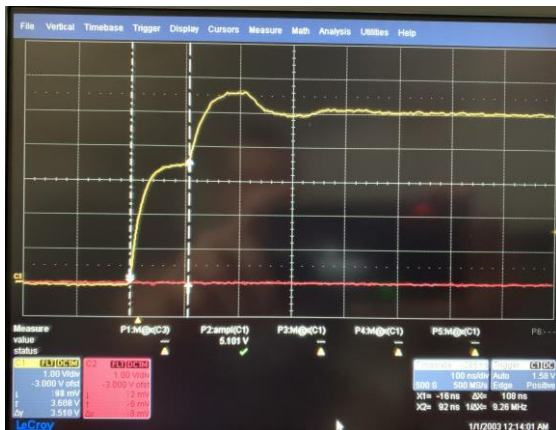

# Laboratorijska vaja 12

## Tipala in signali – praktični izzivi

- 12a: LV5a : Tipala in signali – meritve
  - a) Meritev karakteristične upornosti linije z multimetrom ( $R_0$ )
  - b) Preizkusi različnih tipal (IR, UZ razdalja, PIR, Hall, ...)
  - c) Meritve deformacij UTP kabla
  - d) \*LV2-4 - Presluh – meritve na ploščatem kablu
  
- 12b: LV5b : STM32H7 – Generator signalov
  - a) UART                      PB14
  - b) PWM                        PA3
  - c) SPI                         PD3(SCK),            PI3 (MOSI)
  - d) I2C                         PD12(SCL), PD13(SDA)
  - e) CANBUS                    CN1 (FDCAN1: CAN-L, CAN-H)





## LV2-4\*: Merjenje presluha na ploščatem kabl

- Funkcijski generator priključite na vodnik 1, vodnik 0 pa uporabite kot skupni povratni vodnik GND in nastavite primerno obliko signala  $u_v(t)$ .

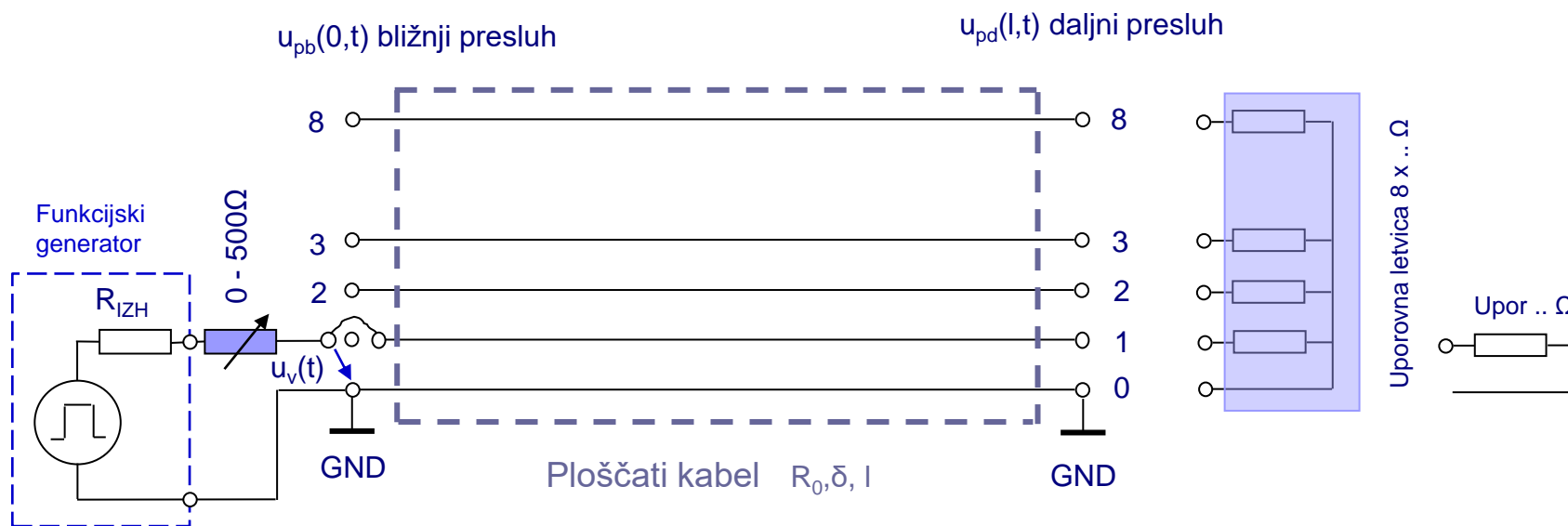

## Merjenje presluha na ploščatem kablju

Funkcijski generator priključite na vodnik 1, vodnik 0 pa uporabite kot skupni povratni vodnik GND in nastavite primerno obliko signala  $u_v(t)$ .

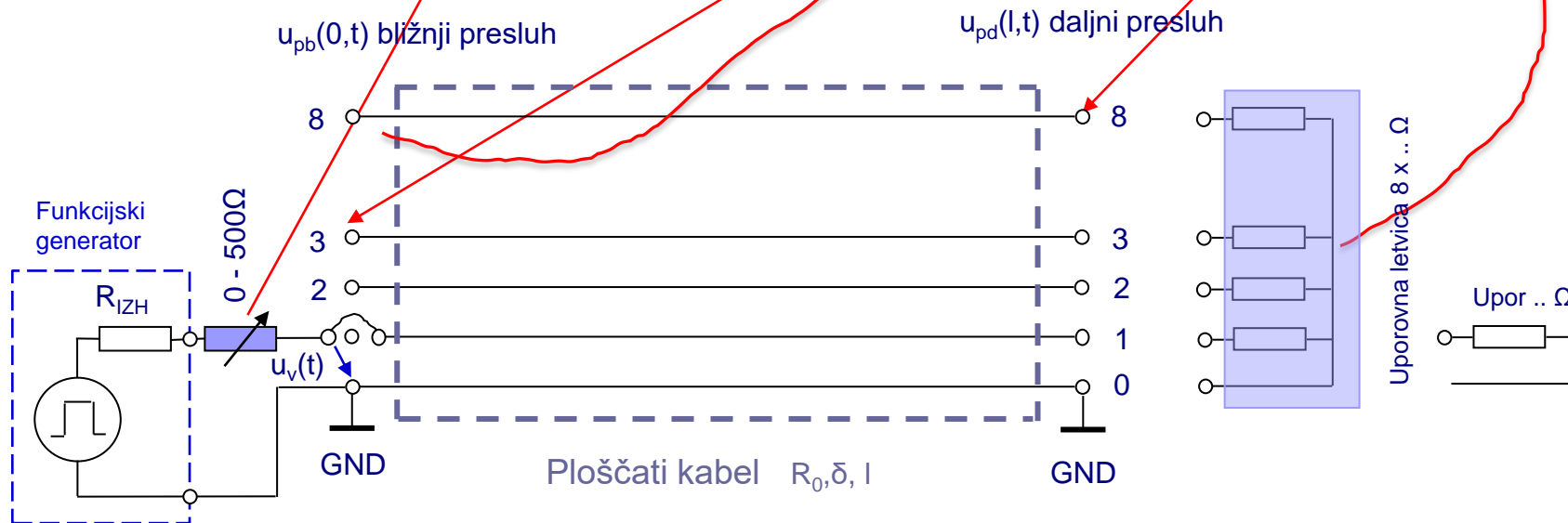
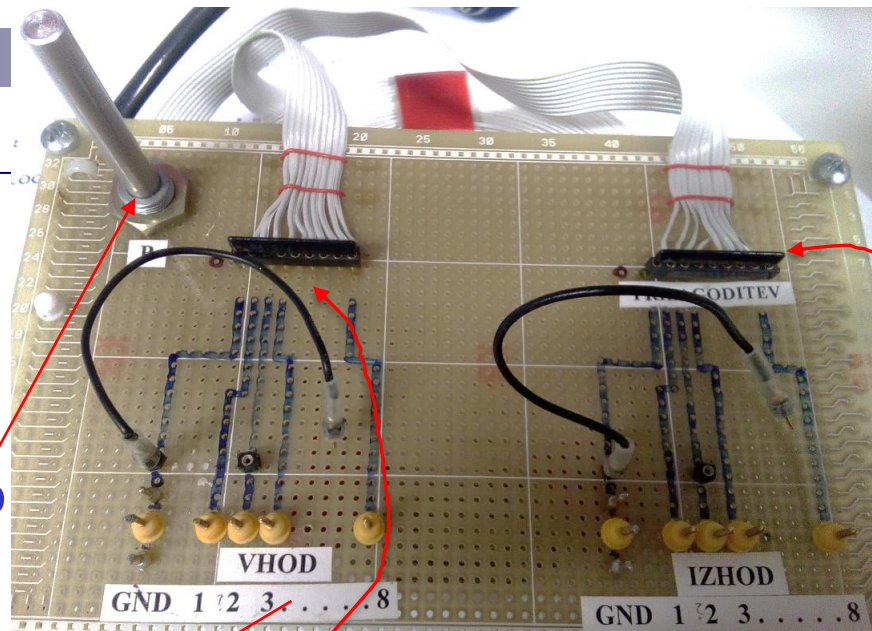

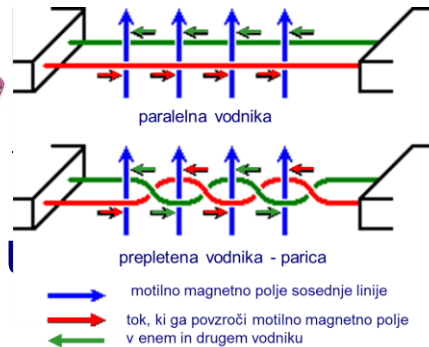

# LV2-4: Merjenje presluha na ploščatem kablu

Pozor: ploščati kabel je precej slabši od UTP glede presluhov :

- ni parica (večji presluh)
- zvitek: presluh se bolj širi

Pri  $R_0$  meritvi ozemljiti linijo 2 (GND) !!!

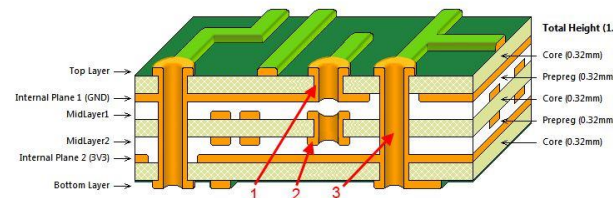

$u_{pb}(0,t)$  bližnji presluh

$u_{pd}(l,t)$  daljni presluh

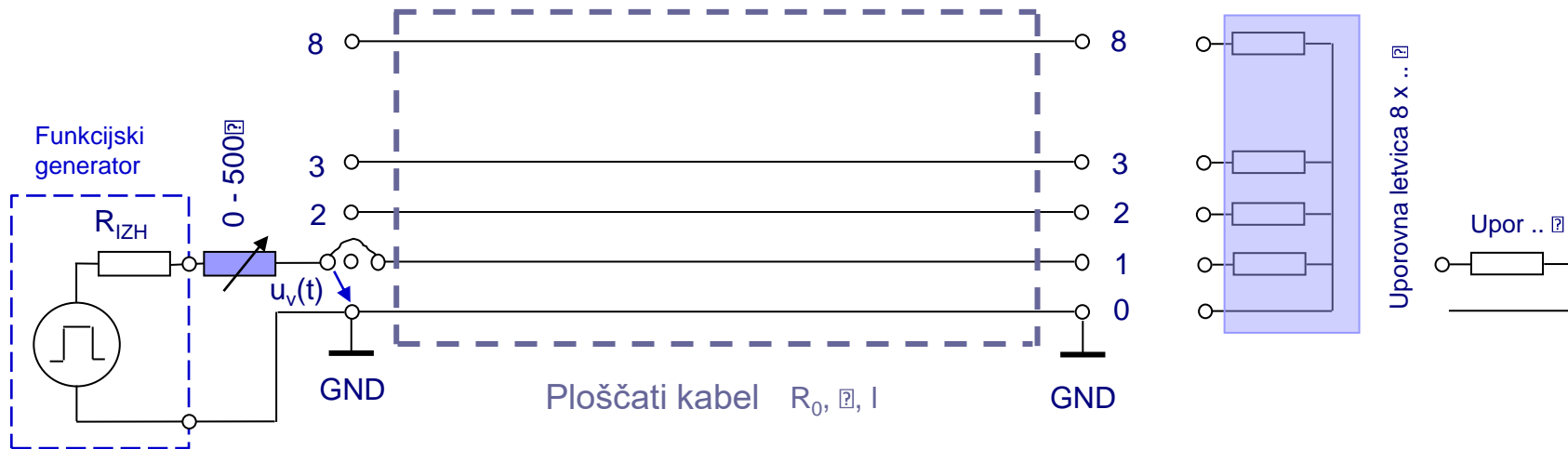

PLOŠČATI KABEL

LINIJA 0-1:

- Ⓐ . ČAS POTOVANJA -  $\tau$
  - Ⓑ . KARAKT. UPORNOST -  $R_0$
- } - LIN. 0-2 ← GND

LINIJE 0-2, 0-3, 0-8:

- Ⓒ  $K_B = ? \leftarrow$  . BLIŽNJI PRESLUH
- . DALJNI PRESLUH

MERITVE:

- . ČASOVNI POTEK
  - . VPLIV ODBOSEV:
    - . BREZ
- Ⓓ } . ODBOS NA ISTI STRANI  
 . ODBOS NA OBEH STRANAH  
 → ZAJLJUČITEV 0-1 Z UPOROM!  
 (DEŠNA STRAN)

. OMEJEVANJE PRESLUHOV:

- Ⓕ } . OZEMLJITEV LINIJE 0-2
- Ⓖ . DALJŠANJE  $x_{tr}, t_d$

POROČILO:

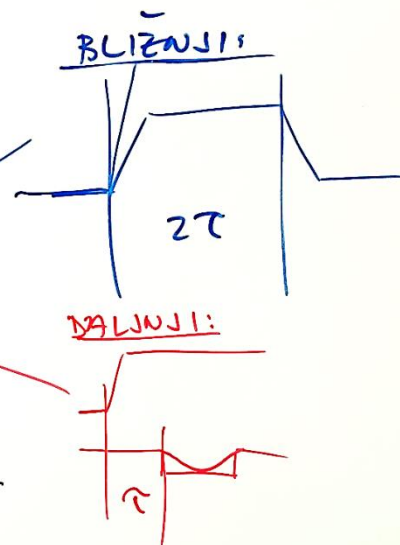

Izhodna upornost funkcijskega generatorja je  $R_{IZH}=50\Omega$ , zakasnitev ploščatega kabla  $\delta=4,53\text{ns/m}$

- Izmerite **čas potovanja** po ploščatem kablu.
- Izmerite in izračunajte **karakteristično upornost ploščatega kabla** in izberite primerno **zaključitev za linije 2 do 8**, da ne bo odbojev (podobno kot v LV 2-2, **linijo 2 ozemljite**).
  - *Kaj se zgodi, če linije 2 ne ozemljite?*
- Izmerite napetostne nivoje **bližnjega presluha**  $u_{pb}(0,t)$  na vhidih v linije 2,3 in 8 in **daljnjega presluha**  $u_{pd}(l,t)$  na izhodih linij 2,3 in 8.
- Opazujte **vpliv zaključitev** na linijah 2 do 8 na amplitudo in potek bližnjega in daljnega presluha (brez odboja, odboj na isti in še na obeh straneh).
- Podajte postopek in izračun **bližnje preslušne konstante**  $K_B$ .

Bližnji presluh (NEXT)

$$u_p(0,t) = K_B \cdot [u_v(t) - u_v(t - 2 \cdot \tau)]$$

PLOŠČATI KABEL

LINIJA 0-1:

- Ⓐ . ČAS POTOVANJA -  $\tau$
  - Ⓑ . KARAKT. UPORNOST -  $R_0$
- } - LIN. 0-2 ← GND

LINIJE 0-2, 0-3, 0-8:

- Ⓒ  $K_B = ? \leftarrow$  . BLIŽNJI PRESLUH
- . DALJNI PRESLUH

MERITVE:

- . ČASOVNI POTEK
  - . VPLIV ODBOSEV:
  - . BREZ
- Ⓓ } . ODBOS NA ISTI STRANI  
 . ODBOS NA OBEH STRANEH  
 → ZAJLJUČITEV 0-1 Z UPOROM!  
 (DEŠNA STRAN)

. OMEJEVANJE PRESLUHOV:

- Ⓕ } . OZEMLJITEV LINIJE 0-2
- Ⓖ . DALJŠANJE  $x_{tr}, t_d$

POROČILO:

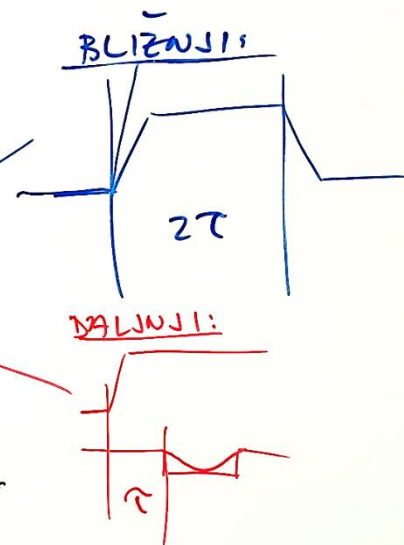

- Izmerite čas potovanja po ploščatem kablu  $\approx 62\text{ns}$

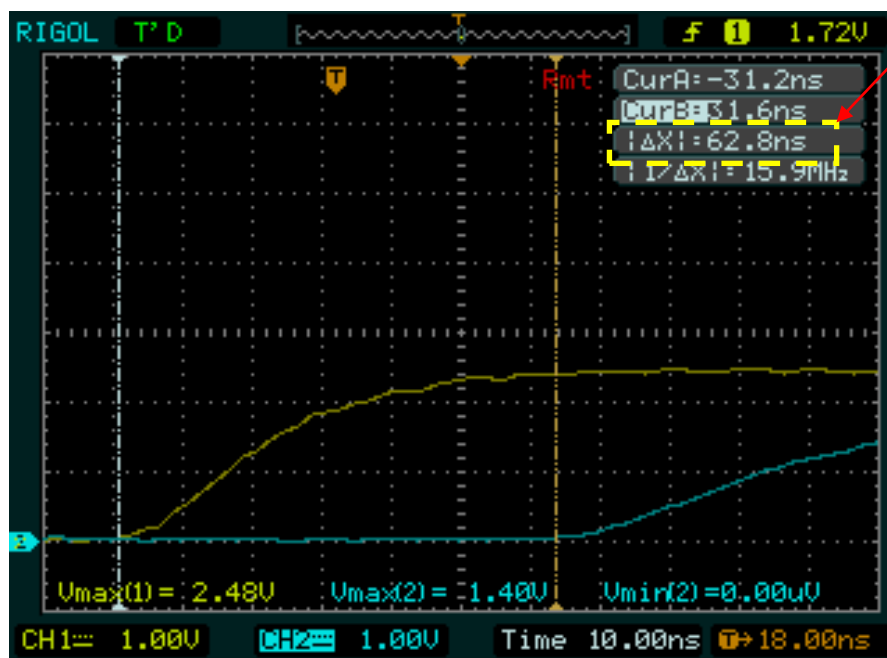

$\approx 62\text{ns}$

PLOŠČATI KABEL

LINIJA 0-1:

- Ⓐ . ČAS POTOVANJA -  $\tau$
  - Ⓑ . KARAKT. UPORNOST -  $R_0$
- } - LIN. 0-2 ← GND

LINIJE 0-2, 0-3, 0-8:

Ⓒ  $K_B = ? \leftarrow$  . **BLIŽNJI PRESLUH**

. **DALJNI PRESLUH**

. DMEJEVANJE PRESLUHOV:

- Ⓕ . DZEMLJITEV LINIJE 0-2
- Ⓖ . DALJŠANJE  $x_{tr}, t_d$

MERITVE:

- . ČASOVNI POTEK:
  - . VPLIV ODBOSEV:
    - . BREZ } Ⓒ
    - . ODBOS NA ISTI STRANI
    - . ODBOS NA OBEH STRANEH
- ZAJLJUČITEV 0-1 Z UPOROM! (DESNA STRAN)

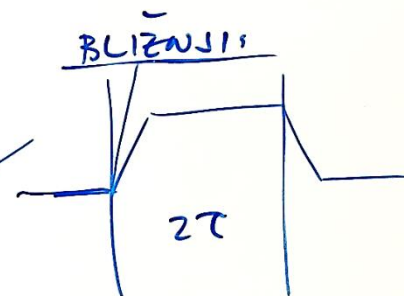

POROČILO:



**REŠ:** Merjenje presluha na ploščatem kablu : Bližnji presluh

- Izmerite napetostne nivoje bližnjega presluha  $u_{pb}(0,t)$  na vlohah v linije 2, 3 in 8

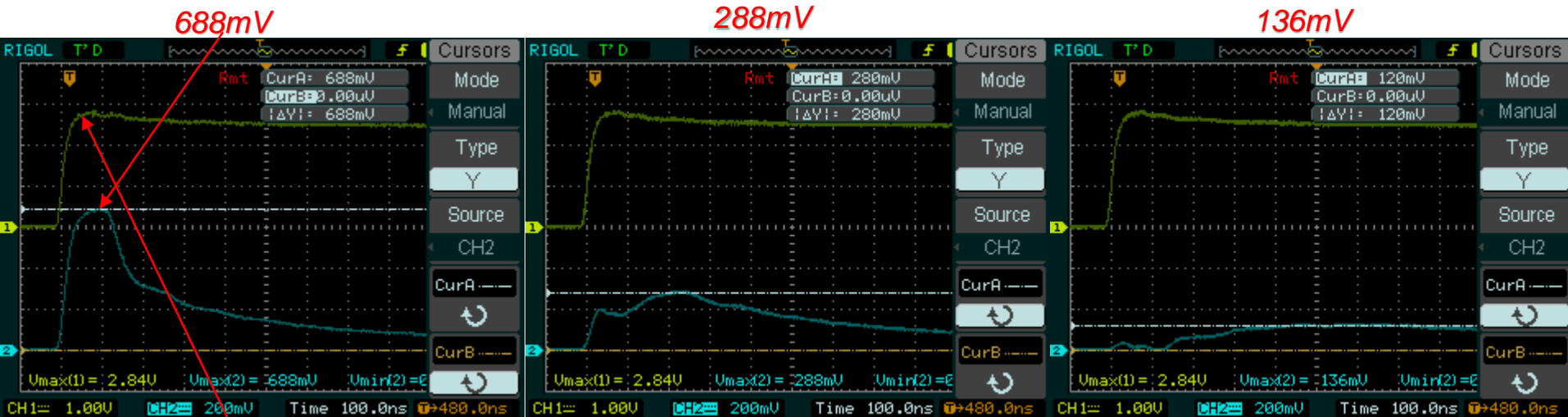

- Primer izračuna  $K_b$  (vstavljene zaključitve)

KABEL #N

-->  $K_b = 0.688 / 2.86$

$K_b =$

0.240559

*Komentar:* 1.slika – vzamem max (2.86V) namesto  $V_{stac}$  (2.54V) za izračun

Bližnji presluh (NEXT)

$$u_p(0,t) = K_B \cdot [u_v(t) - u_v(t - 2 \cdot \tau)]$$

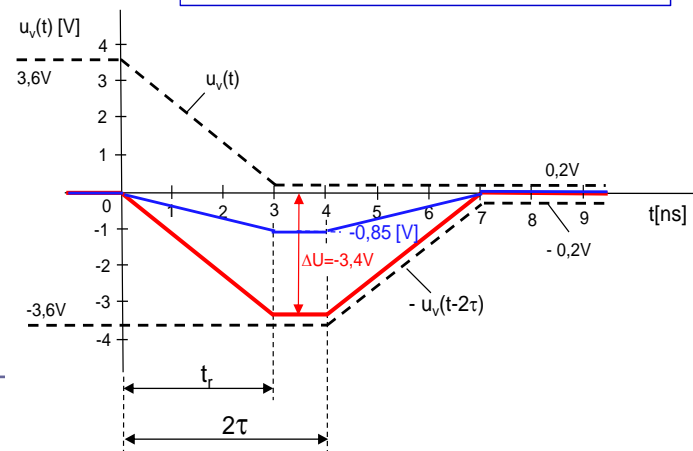

# Vpliv zaključitev na linijah 2, 3 in 8 (stolpci) na amplitudo in potek bližnjega presluha

Bližnji-presluh

A) Vstavljene zaključitve

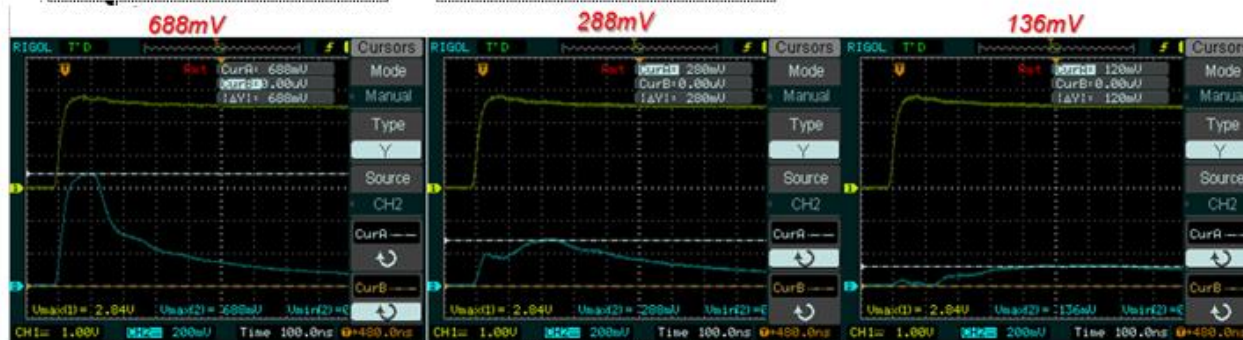

B) Brez zaključitev na isti strani

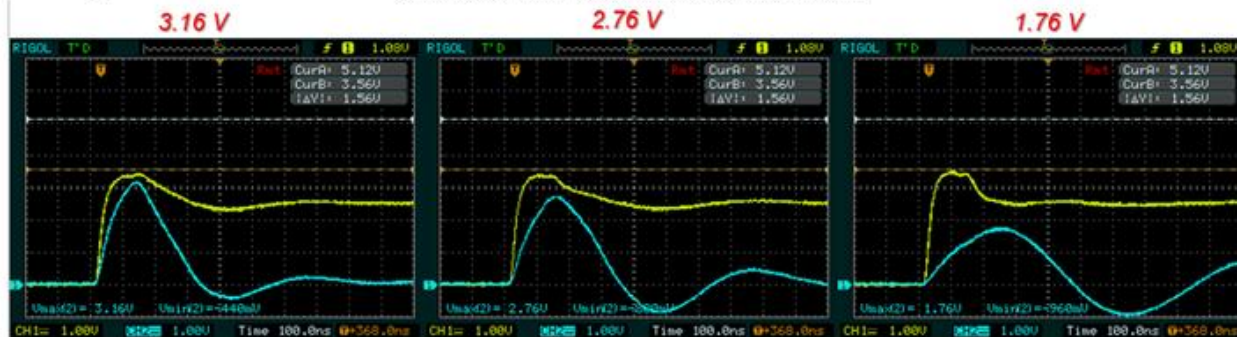

C) Brez zaključitev na obeh straneh

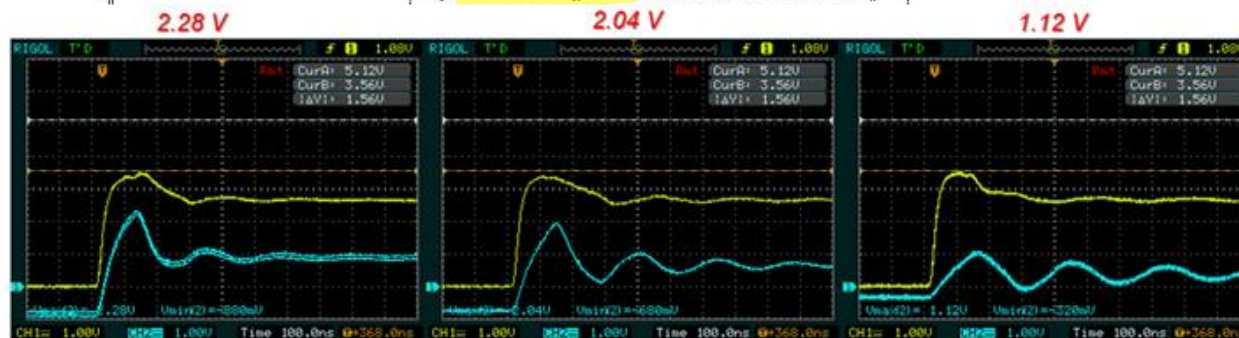

PLOŠČATI KABEL

LINIJA 0-1:

- Ⓐ . ČAS POTOVANJA -  $\tau$
  - Ⓑ . KARAKT. UPORNOST -  $R_0$
- } - LIN. 0-2 ← GND

LINIJE 0-2, 0-3, 0-8:

- Ⓒ  $K_B = ? \leftarrow$  . BLIŽNJI PRESLUH
- . DALJNI PRESLUH

MERITVE:

- . ČASOVNI POTEK
- . VPLIV ODBOSEV:
  - . BREZ } Ⓒ
  - . ODBOS NA ISTI STRANI
  - . ODBOS NA OBEH STRANEH
- ZAJKLJUČITEV 0-1 Z UPOROM! (DESNA STRAN)

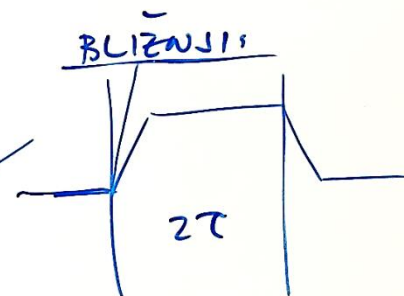

. OMEJEVANJE PRESLUHOV:

- Ⓕ . OZEMLJITEV LINIJE 0-2
- Ⓖ . DALJŠANJE  $x_{tr}, t_d$

POROČILO:

REŠ: Merjenje presluha na ploščatem kablu : Daljni presluh

Izmerite napetostne nivoje daljnega presluha  $u_{pd}(l,t)$  na izhodih linij 2,3 in 8.

-360mV

-320mV

-120mV

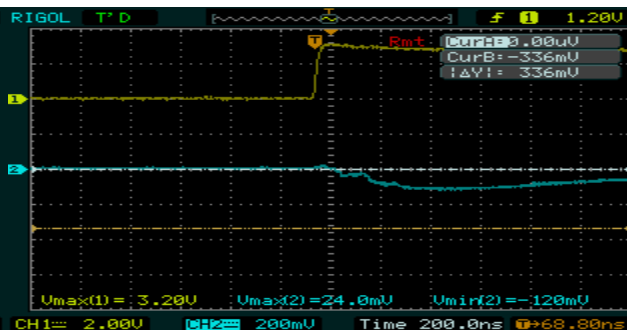
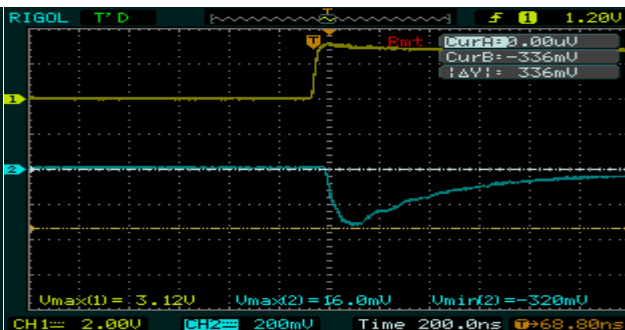
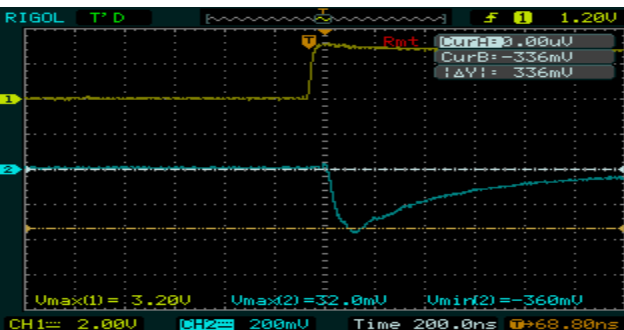

□ Brez zaključitve na daljni strani (spodaj) in obeh straneh (čisto spodaj)

-1.88 V

< -2V

-1.4 V

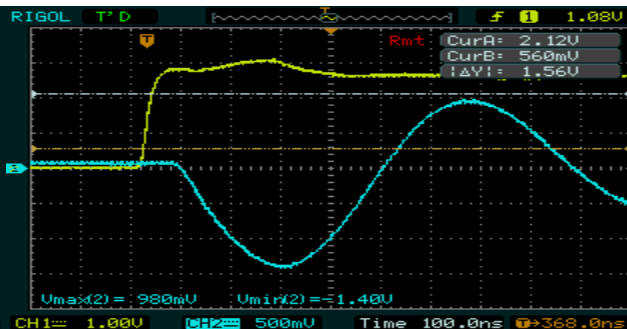
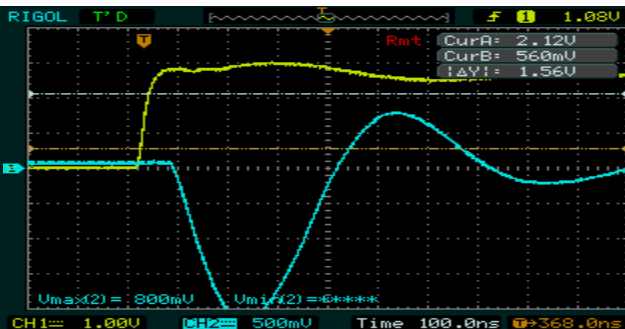
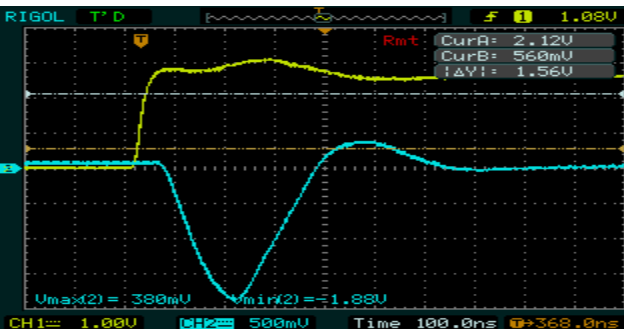

1.06 V

1.04 V

0.66 V

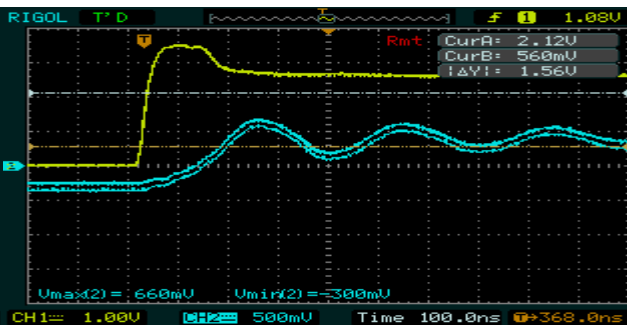
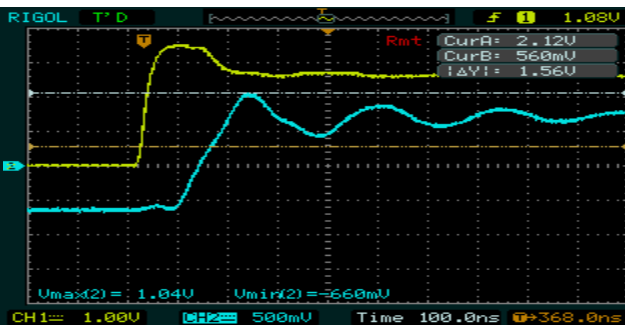
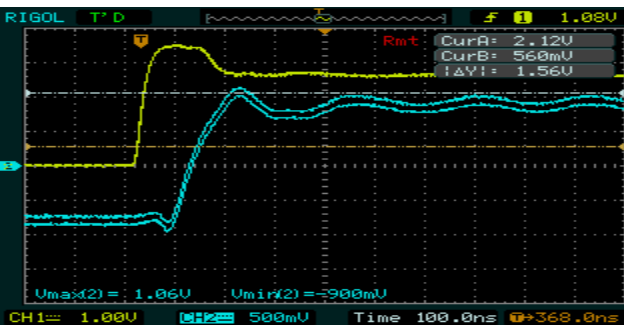

# Omejevanje presluha

## ■ Presluh lahko zmanjšamo z več različnimi ukrepi:

- Z večanjem razmerja  $t_r / \tau$  (čas vzpona signala / čas potovanja signala po liniji)
- Z manjšanjem spremembe napetosti  $\Delta U$  pri spremembi stanja ( $0 \rightarrow 1$ ,  $1 \rightarrow 0$ )
- Z manjšanjem preslušnih konstant  $K_B$  in  $K_F$  :
  - Večplastna tiskana vezja
  - Večje število povratnih (ozemljitvenih) vodnikov
  - Prepleteni vodniki (parica)
  - Oklopljena parica
  - Koaksialni kabel
  - Simetrični (diferencialni) prenos
  - Optični vodniki
- Upoštevanje občutljivosti na presluh pri različnih vrstah signalov

PLOŠČATI KABEL

LINIJA 0-1:

- Ⓐ . ČAS POTOVANJA -  $\tau$
  - Ⓑ . KARAKT. UPORNOST -  $R_0$
- } - LIN. 0-2 ← GND

LINIJE 0-2, 0-3, 0-8:

- Ⓒ  $K_B = ? \leftarrow$  . BLIŽNJI PRESLUH
- . DALJNI PRESLUH

MERITVE:

- . ČASOVNI POTEK
  - . VPLIV ODBOSEV:
  - . BREZ
- } Ⓒ

- Ⓓ . ODBOS NA ISTI STRANI
  - . ODBOS NA OBEH STRANEH
- ZAKLJUČITEV 0-1 Z UPOROM!  
(DESNA STRAN)

• OMEJEVANJE PRESLUHOV:

• OZEMLJITEV LINIJE 0-2

- Ⓕ . DALJŠANJE  $x_{tr}, t_d$

POROČILO:

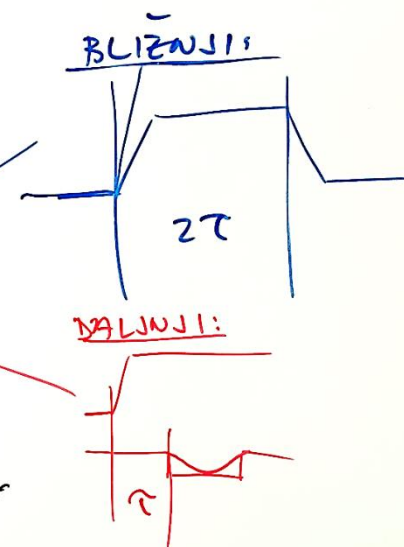

## Manjšanje preslušnih konstant $K_B$ in $K_F$

### Večplastna tiskana vezja

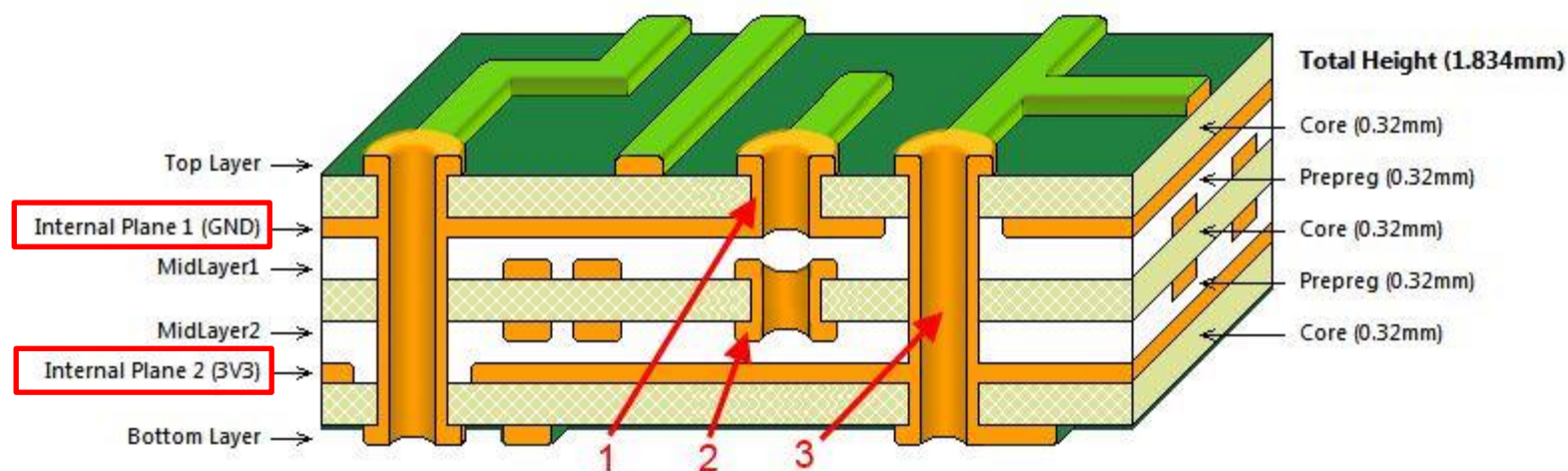

Vmesna plast z ozemljitvenimi in napajalnimi povezavami zmanjšuje medsebojni vpliv povezav v plasti 1 in zgornji plasti ter povezav v plasti 2 in spodnji plasti.

## Omejevanje presluha na ploščatem kablu

- Opazujte **vpliv ozemljitve na liniji 2** (na enem ali obeh koncih) na amplitudo bližnjega in daljnega presluha na liniji 3.
- Na funkcijskem generatorju **spreminjajte čas vzpona  $t_r$**  in čas padca signala  $t_f$  in opazujte vpliv na presluh (bližnji in daljnji).
  - Pri kateri vrednosti  $t_r$  oziroma  $t_f$  se presluh začne manjšati ?
  - Kako se to vidi na osciloskopu ?



## Omejevanje presluha na ploščatem kablu - ozemljitev

- Opazujte vpliv ozemljitve na liniji 2 (na enem ali obeh koncih) na amplitudo bližnjega in daljnega presluha na liniji 0-3.

brez  
ozemljitve  
312 mV

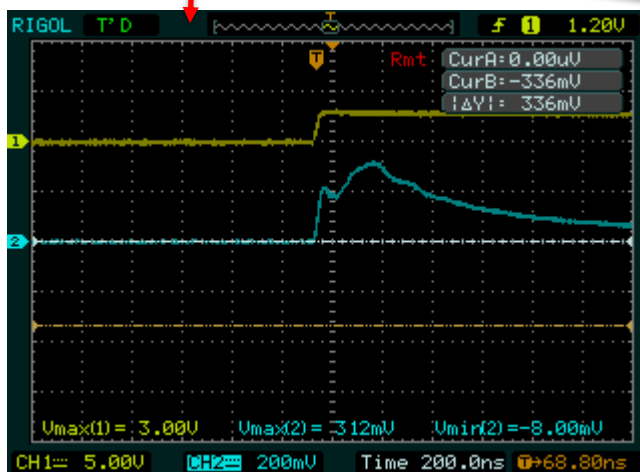

-368mV

ozemljitev  
2 - GND  
32 mV

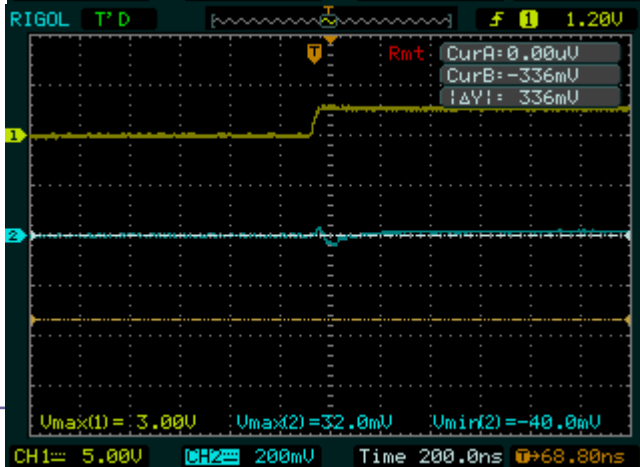

136mV

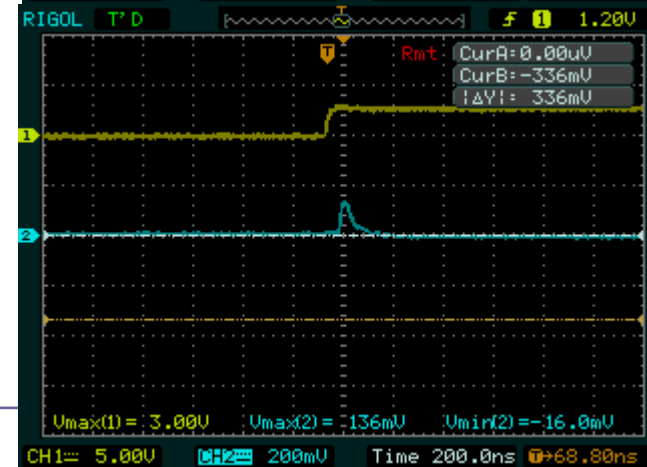
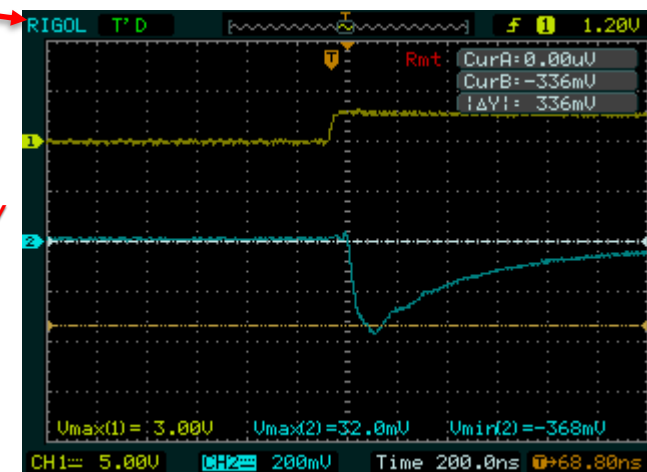

Bližnji presluh

Daljnji presluh

PLOŠČATI KABEL

LINIJA 0-1:

- Ⓐ . ČAS POTOVANJA -  $\tau$
  - Ⓑ . KARAKT. UPORNOST -  $R_0$
- } - LIN. 0-2 ← GND

LINIJE 0-2, 0-3, 0-8:

- Ⓓ  $K_B = ? \leftarrow$  . BLIŽNJI PRESLUH
- . DALJNI PRESLUH

MERITVE:

- . ČASOVNI POTEK
  - . VPLIV ODBOSEV:
  - . BREZ
- } Ⓒ

- Ⓔ . ODBOS NA ISTI STRANI
  - . ODBOS NA OBEH STRANEH
- ZAJLJUČITEV 0-1 Z UPOROM! (DEŠNA STRAN)

. OMEJEVANJE PRESLUHOV:

- Ⓕ . OZEMLJITEV LINIJE 0-2
- Ⓖ . DALJŠANJE  $x_{tr}, t_d$

POROČILO:

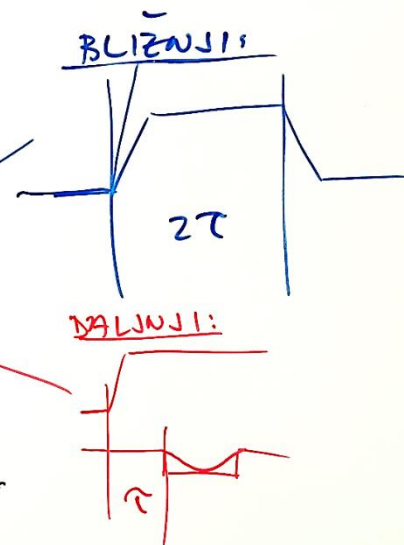

REŠ: Merjenje presluha na ploščatem kablu

## Omejevanje presluha na ploščatem kablu – čas vzpona

- Na funkcijskem generatorju spreminjajte čas vzpona  $t_r$  in čas padca signala  $t_f$  in opazujte vpliv na presluh.
  - Pri kateri vrednosti  $t_r$  oziroma  $t_f$  se presluh začne manjšati?
  - Kako se to vidi na osciloskopu ?

$t_r \approx 62 \text{ ns}$

$t_r \approx 100 \text{ ns}$

$t_r \approx 150 \text{ ns}$

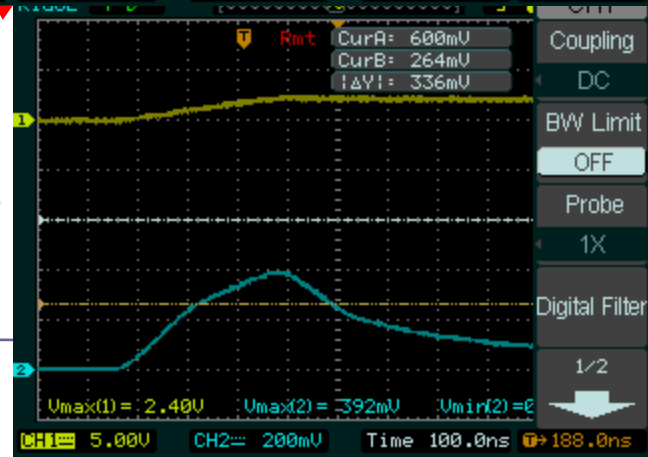
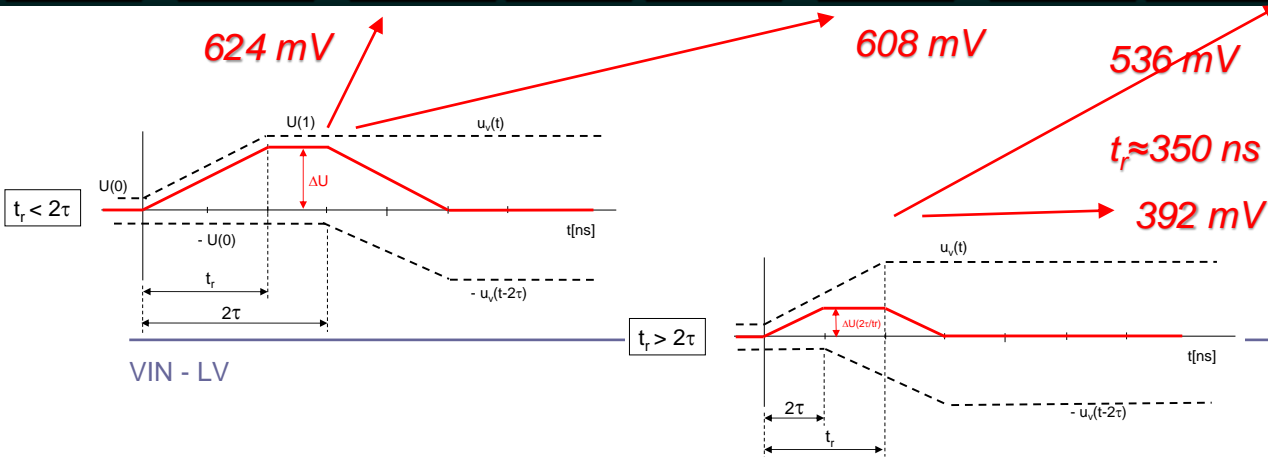
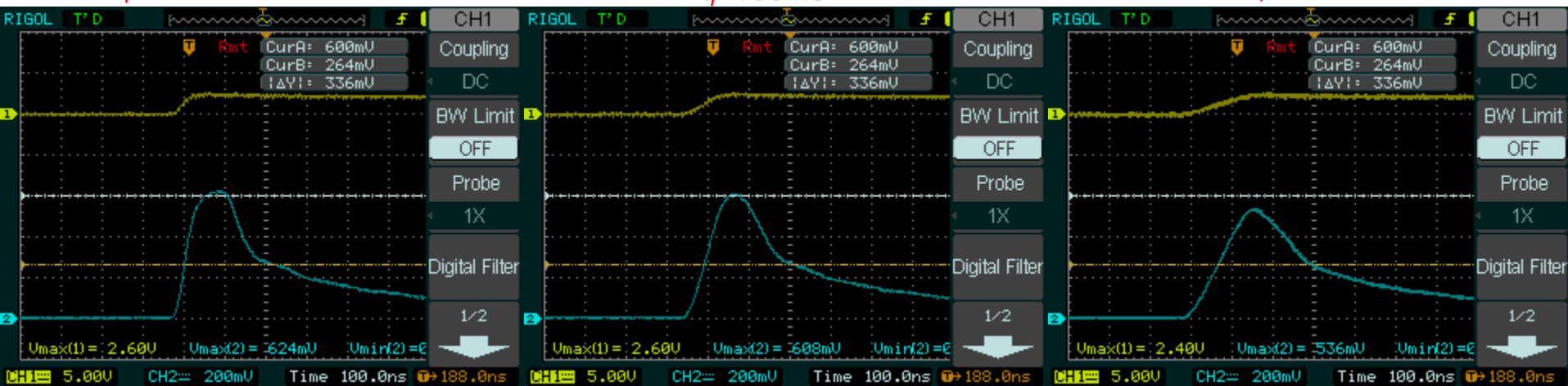

# Laboratorijska vaja 12

## Tipala in signali – praktični izzivi

- 12a: LV5a : Tipala in signali – meritve
  - a) Meritev karakteristične upornosti linije z multimetrom ( $R_0$ )
  - b) Preizkusi različnih tipal (IR, UZ razdalja, PIR, Hall, ...)
  - c) Meritve deformacij UTP kabla
  - d) \*LV2-4 - Presluh – meritve na ploščatem kablu

### ■ 12b: LV5b : STM32H7 – Generator signalov

- a) UART                      PB14
- b) PWM                        PA3
- c) SPI                         PD3(SCK),            PI3 (MOSI)
- d) I2C                         PD12(SCL), PD13(SDA)
- e) CANBUS                    CN1 (FDCAN1: CAN-L, CAN-H)

# STM32H750B – DISCOVERY StMod+ konektor

**3.3V !!!**

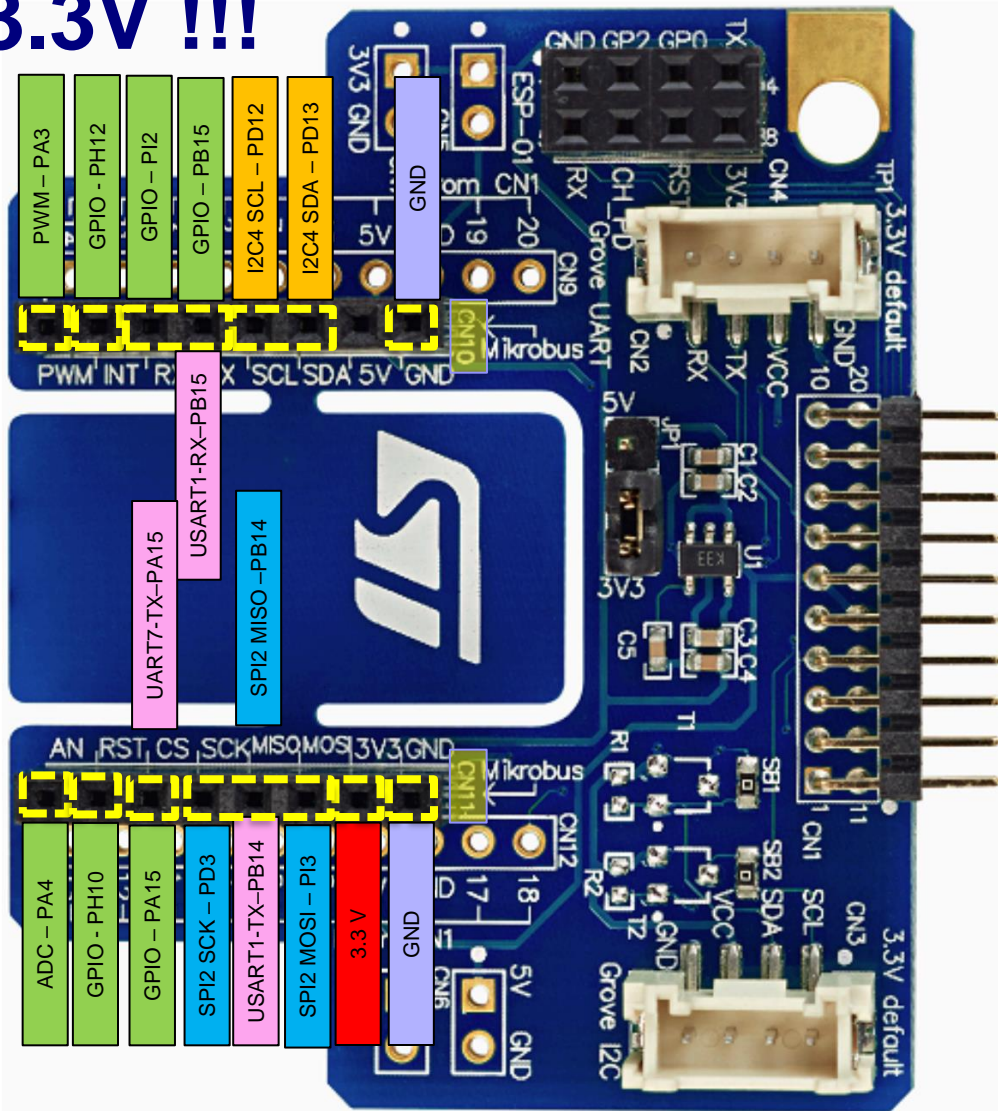

Pravilna priključitev

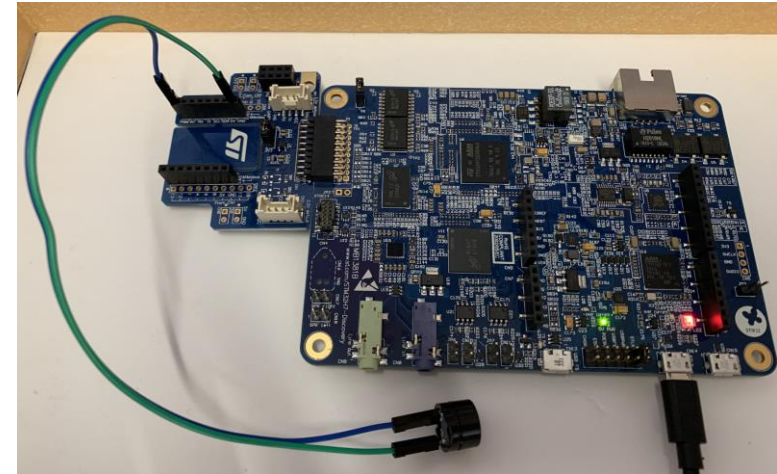

Neppravilna priključitev



<https://www.st.com/en/evaluation-tools/stm32h750b-dk.html>

# 3.3V !!!

## STM32H750B – DISCOVERY StMod+ konektor

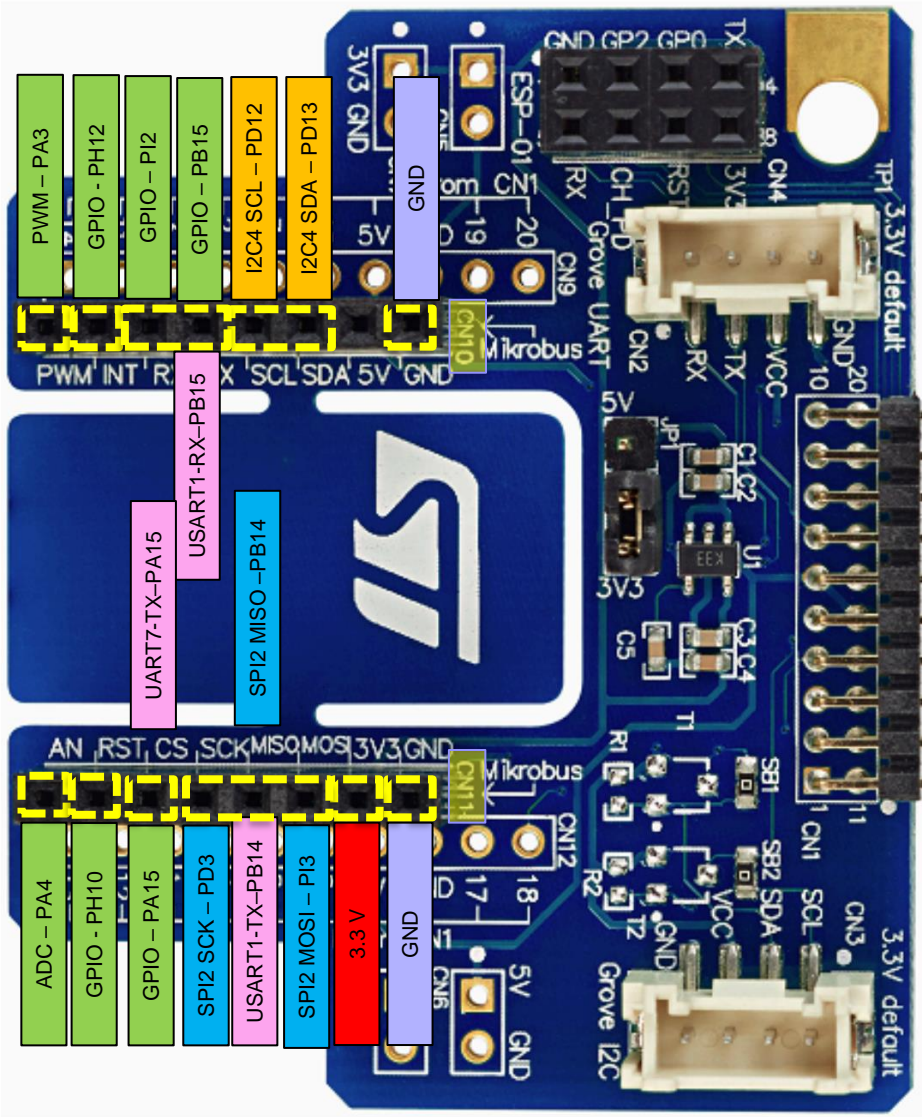

### Mikrobus connectors

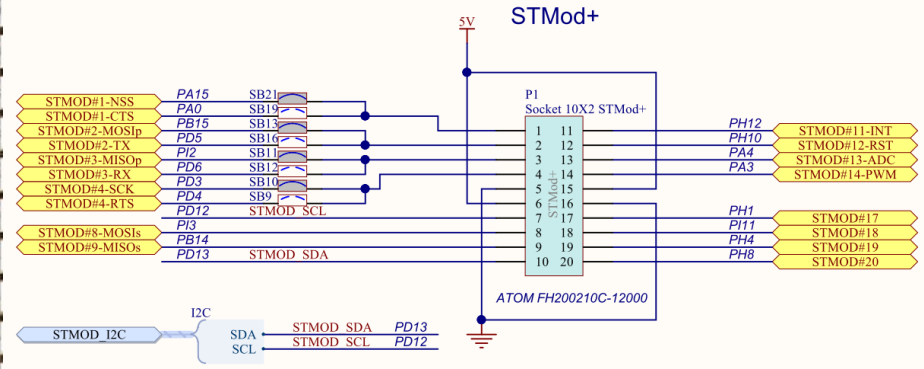
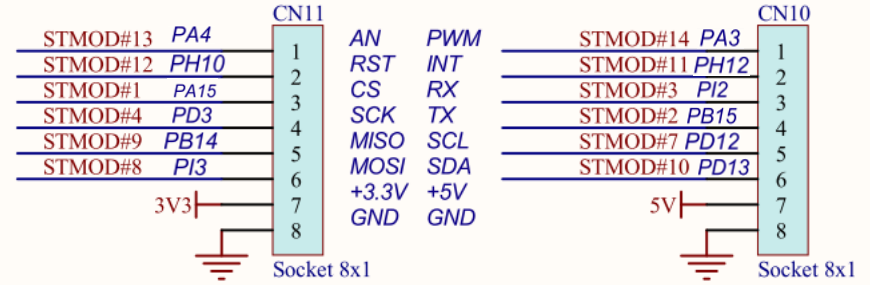

**STM32H7**

# 3.3V !!!

## STM32H750B – DISCOVERY StMod+ konektor

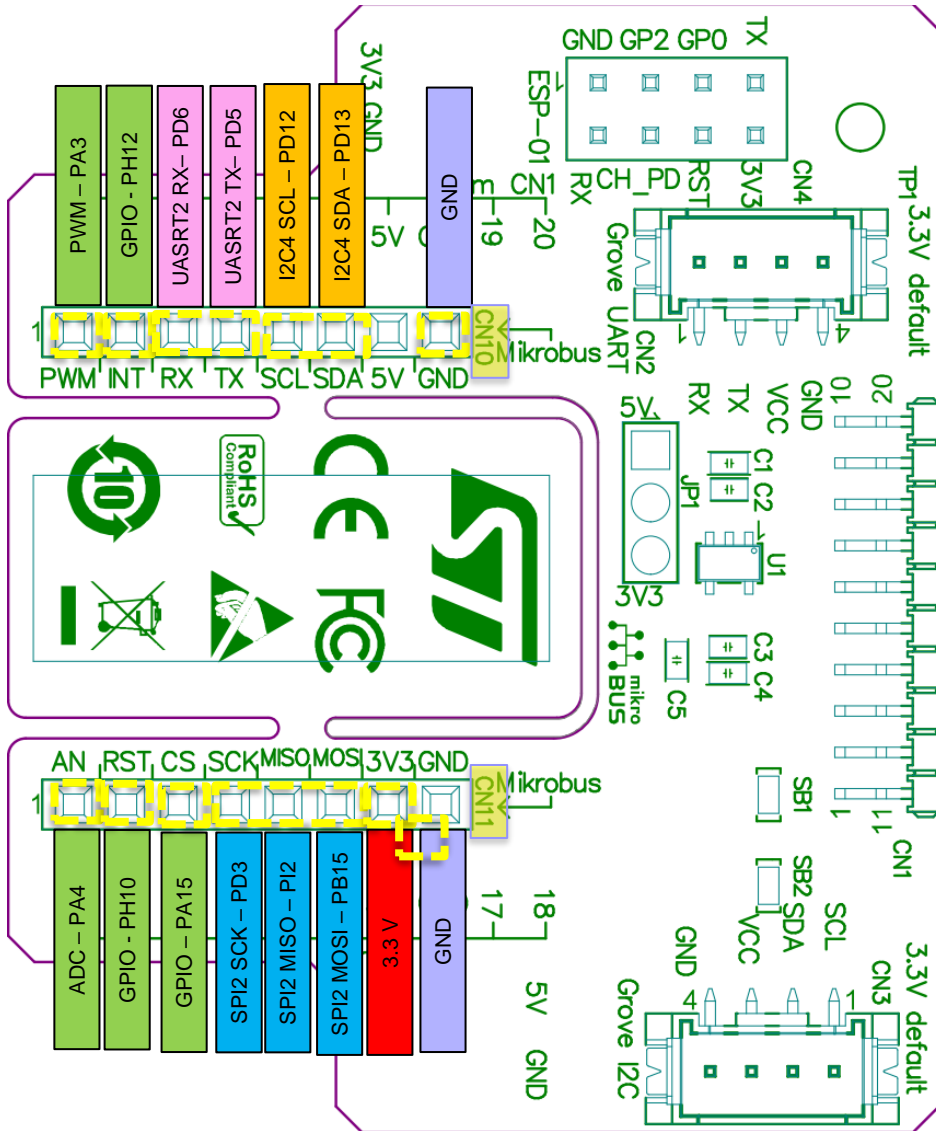

### Mikrobus connectors

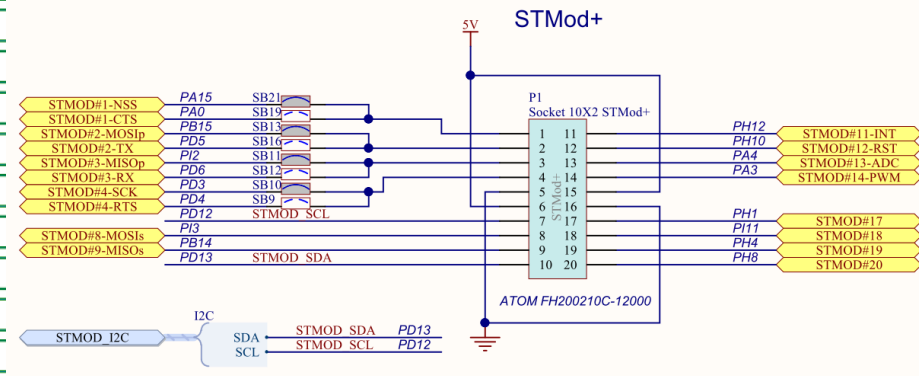
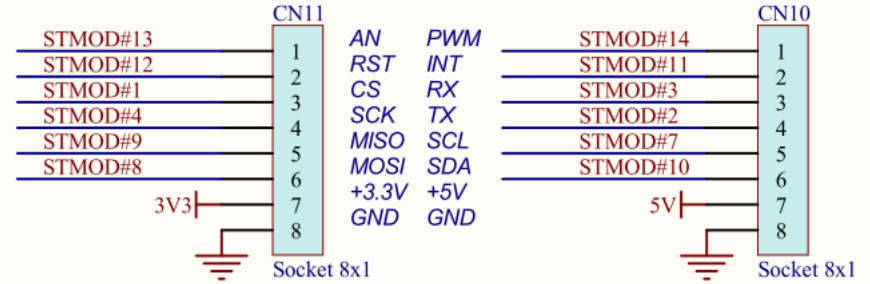

**STM32H7**





# Izzivi - povezave

- PWM PA3
- UART PB14
- SPI PD3(SCK), PI3 (MOSI)
- I2C PD12(SCL), PD13(SDA)
- CANBUS CN1 (FDCAN1)
  - CAN-L, CAN-H

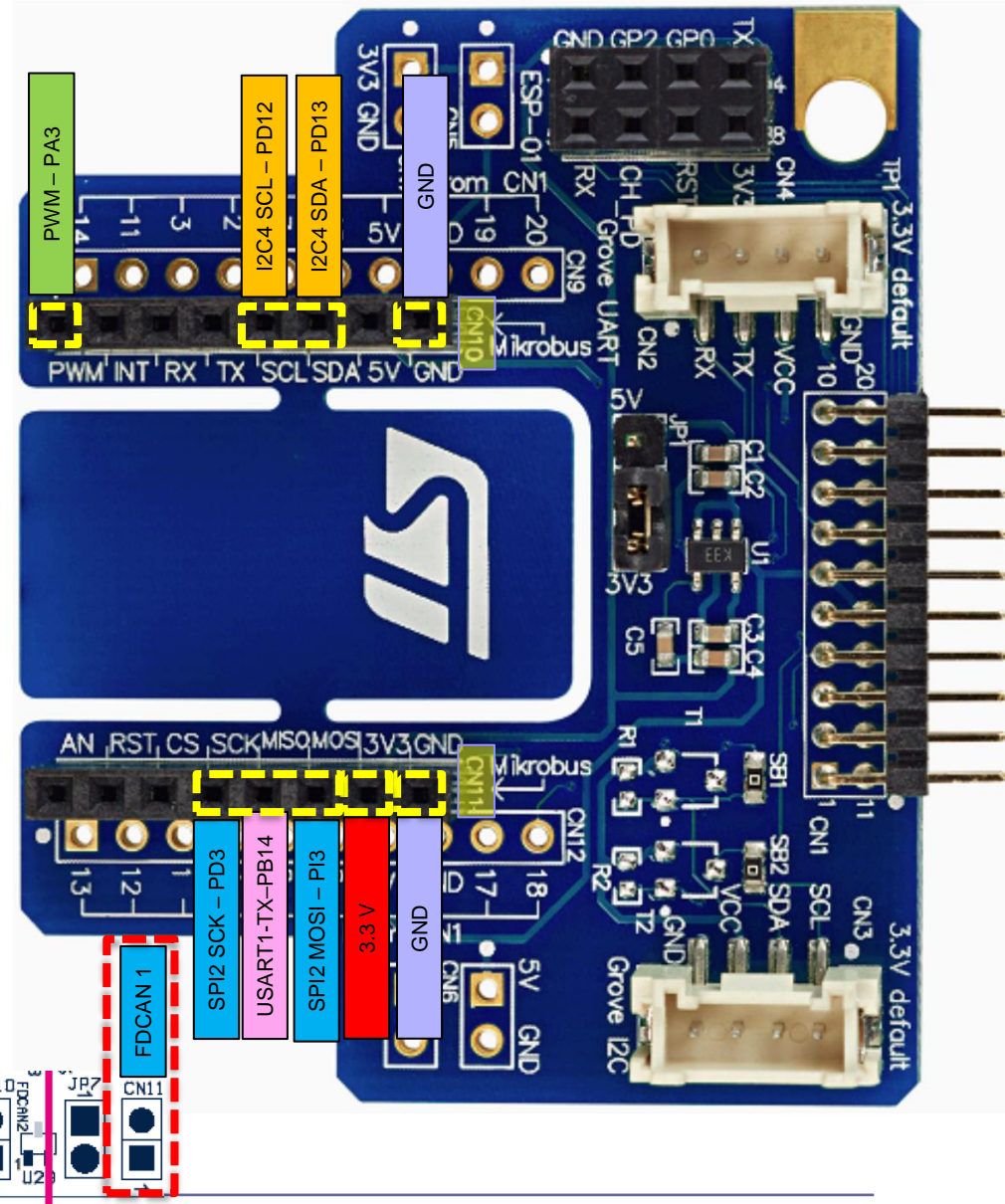
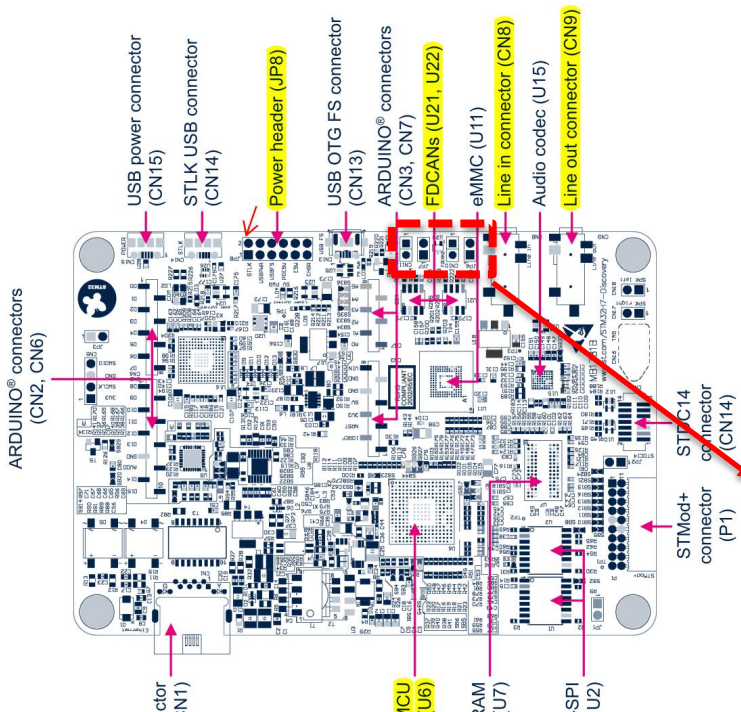

Figure 5. STM32H745I-DISCO and STM32H750B-DK Discovery board bottom layout

# Laboratorijska vaja 12

## Tipala in signali – praktični izzivi

- 12a: LV5a : Tipala in signali – meritve
  - a) Meritev karakteristične upornosti linije z multimetrom ( $R_0$ )
  - b) Preizkusi različnih tipal (IR,UZ razdalja, PIR, Hall, ...)
  - c) Meritve deformacij UTP kabla
  - d) \*LV2-4 - Presluh – meritve na ploščatem kablu

- 12b: LV5b : STM32H7 – Generator signalov

- |    |        |                            |
|----|--------|----------------------------|
| a) | UART   | PB14                       |
| b) | PWM    | PA3                        |
| c) | SPI    | PD3(SCK), PI3 (MOSI)       |
| d) | I2C    | PD12(SCL), PD13(SDA)       |
| e) | CANBUS | CN1 (FDCAN1: CAN-L, CAN-H) |

## UART komunikacija (TTL ali RS232 napetostni nivoji)

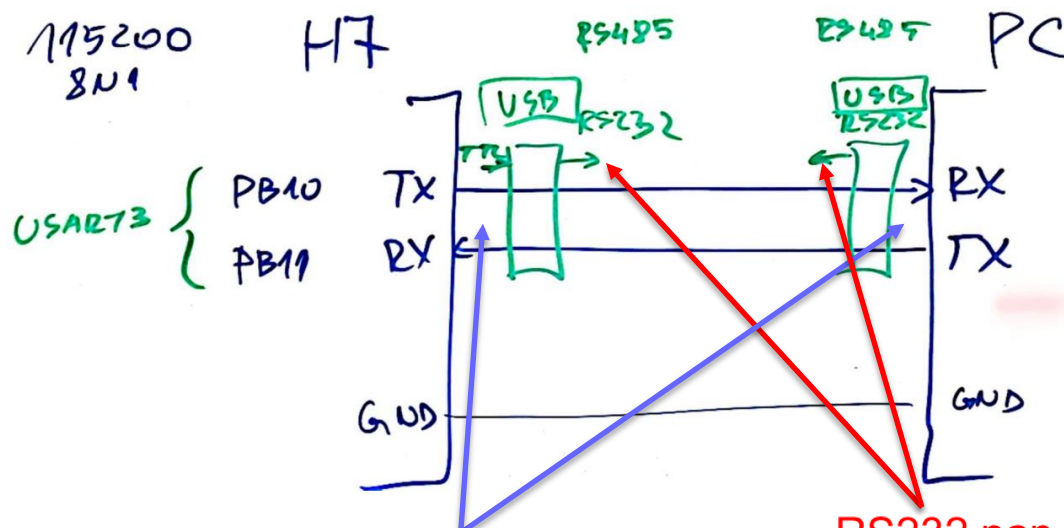

Napetostni nivoji za CMOS vezja 74HCT in ACT

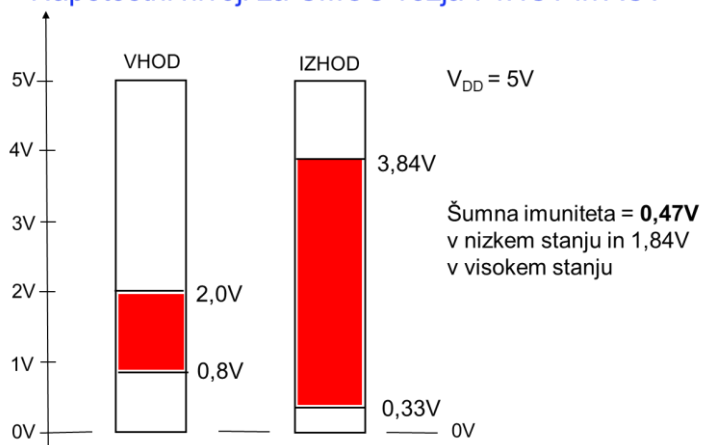

RS232 nap. nivoji

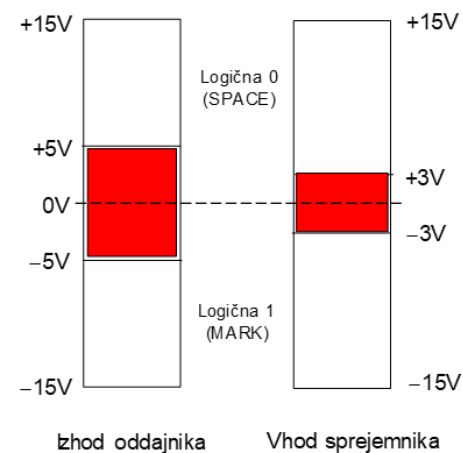

Določite **bitno hitrost** prenosa in ugotovite **ASCII kodo znakov**, ki se prenašajo ob nastavitvi 8N1 (8 podatkovnih bitov, brez paritetnega bita, 2 stop bita).

## ■ Primer poteka signala TTL – nastavitve „8N1“:

### □ Napetostna in logična nivoja

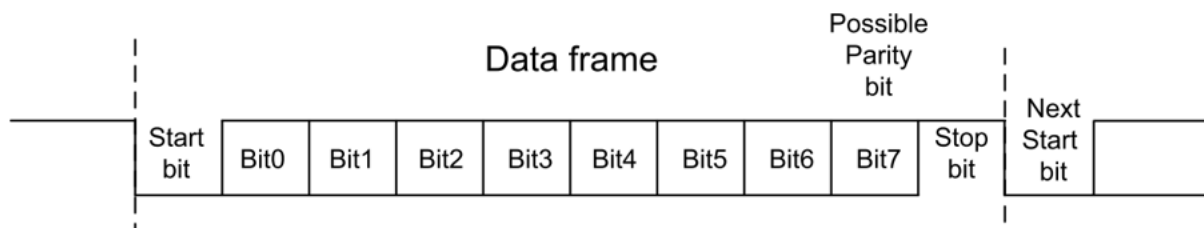

Napetostni nivoji za CMOS vezja 74HCT in ACT

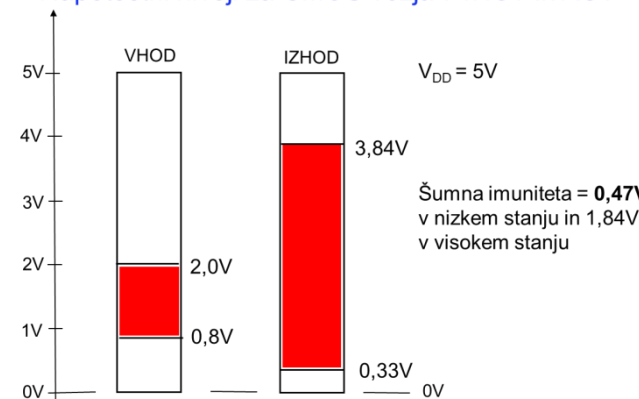

Nastavitve TTL na prikazani sliki – „8N1“:

- 8 podatkovnih bitov
- Ni paritetnega bita
- 1 stop bit

Določite **bitno hitrost** prenosa in ugotovite **ASCII kodo znakov**, ki se prenašajo ob nastavitvi 8N1 (8 podatkovnih bitov, brez paritetnega bita, 2 stop bita).

■ Primer poteka signala **RS232** – nastavitve „7P2“:

□ Napetostna in logična nivoja

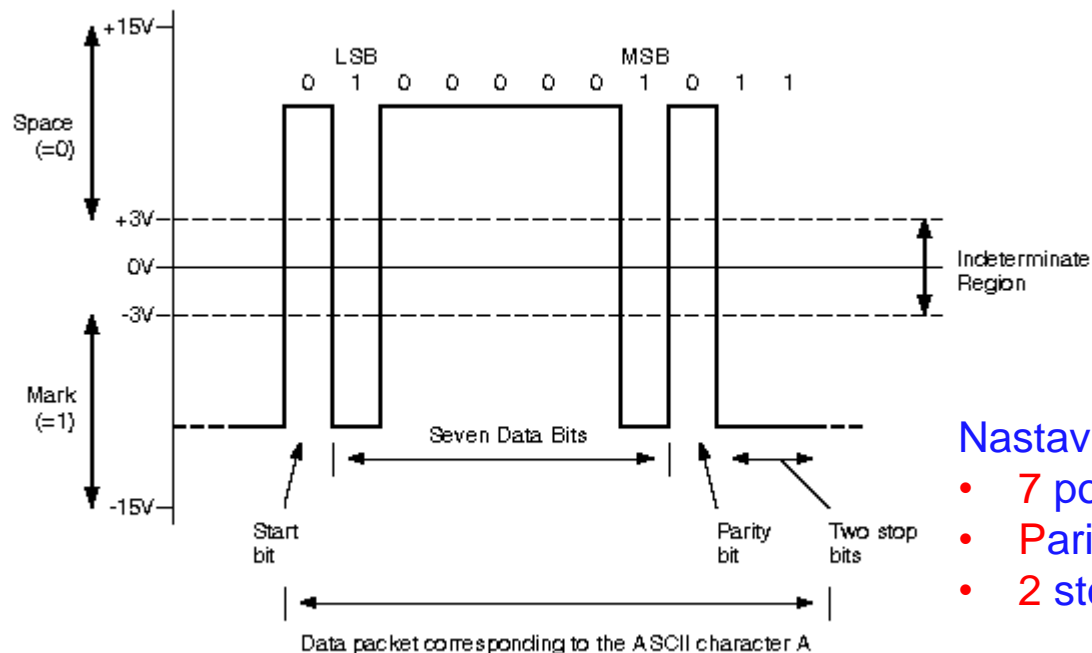

**RS232 nap. nivoji**

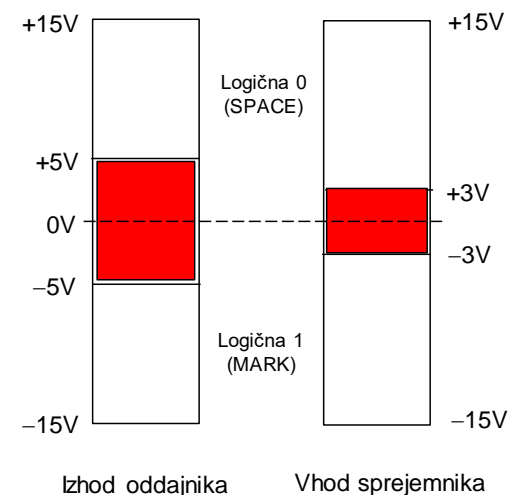

Nastavitve RS232 na prikazani sliki – „7P2“:

- 7 podatkovnih bitov
- Paritetni bit
- 2 stop bita

# Laboratorijska vaja 12

## Tipala in signali – praktični izzivi

- 12a: LV5a : Tipala in signali – meritve
  - a) Meritev karakteristične upornosti linije z multimetrom ( $R_0$ )
  - b) Preizkusi različnih tipal (IR,UZ razdalja, PIR, Hall, ...)
  - c) Meritve deformacij UTP kabla
  - d) \*LV2-4 - Presluh – meritve na ploščatem kablu

- 12b: LV5b : STM32H7 – Generator signalov

- |    |        |                            |
|----|--------|----------------------------|
| a) | UART   | PB14                       |
| b) | PWM    | PA3                        |
| c) | SPI    | PD3(SCK), PI3 (MOSI)       |
| d) | I2C    | PD12(SCL), PD13(SDA)       |
| e) | CANBUS | CN1 (FDCAN1: CAN-L, CAN-H) |

## Laboratorijska vaja 12 (LV5): STM32H7 generator (UART, PWM, SPI, I2C, CAN)

Določite **frekvenco PWM signala** in **ustrezno noto**.

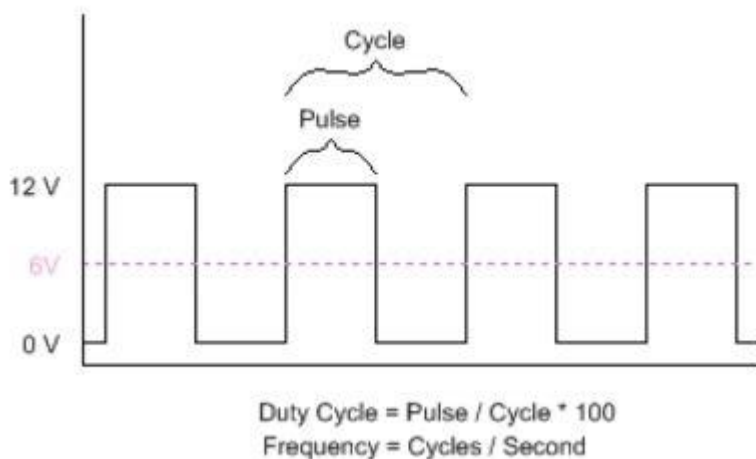

*Example of a PWM signal at 50% duty cycle*

```
#define NOTE_A3 220
#define NOTE_AS3 233
#define NOTE_B3 247
#define NOTE_C4 262
#define NOTE_CS4 277
#define NOTE_D4 294
#define NOTE_DS4 311
#define NOTE_E4 330
#define NOTE_F4 349
#define NOTE_FS4 370
#define NOTE_G4 392
#define NOTE_GS4 415
#define NOTE_A4 440
#define NOTE_AS4 466
#define NOTE_B4 494
#define NOTE_C5 523
#define NOTE_CS5 554
#define NOTE_D5 587
#define NOTE_DS5 622
#define NOTE_E5 659
#define NOTE_F5 698
#define NOTE_FS5 740
#define NOTE_G5 784
#define NOTE_GS5 831
#define NOTE_A5 880
#define NOTE_AS5 932
#define NOTE_B5 988
```

# Laboratorijska vaja 12

## Tipala in signali – praktični izzivi

- 12a: LV5a : Tipala in signali – meritve
  - a) Meritev karakteristične upornosti linije z multimetrom ( $R_0$ )
  - b) Preizkusi različnih tipal (IR, UZ razdalja, PIR, Hall, ...)
  - c) Meritve deformacij UTP kabla
  - d) \*LV2-4 - Presluh – meritve na ploščatem kablu
  
- 12b: LV5b : STM32H7 – Generator signalov
  - a) UART                      PB14
  - b) PWM                        PA3
  - c) SPI                         PD3(SCK),            PI3 (MOSI)
  - d) I2C                         PD12(SCL), PD13(SDA)
  - e) CANBUS                    CN1 (FDCAN1: CAN-L, CAN-H)



### 5 Digital main blocks

#### 5.1 State machine

The LIS3DSH embeds **two state machines** able to run a user defined program.

The program is made up of a set of instructions that define the transition to successive states. Conditional branches are possible.

**From each state (n) it is possible to have transition to the next state (n+1) or to reset state.**

Transition to reset point happens when "RESET condition" is true; Transition to the next step happens when "NEXT condition" is true.

**Interrupt is triggered when output/stop/continue state is reached.**

**Each state machine allows to implement gesture recognition** in a flexible way, free-fall, wake-up, 4D/6D orientation, pulse counter and step recognition, click/double click, shake/double shake, face-up/face-down, turn/double turn:

Table 8. LIS3DSH state machines: sequence of state to execute an algorithm

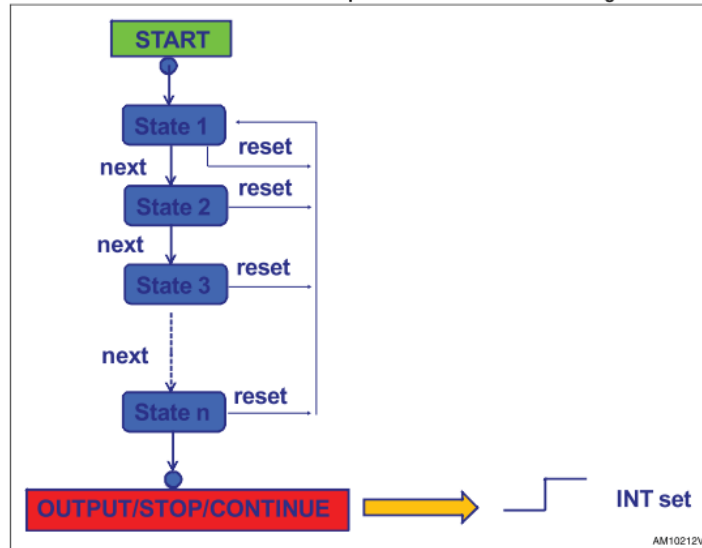

### SPI - serial peripheral interface

Subject to general operating conditions for Vdd and Top.

#### SPI slave timing values

Parameter	Value (1)		Unit
	Min.	Max.	
SPI clock cycle	100		ns
SPI clock frequency		10	MHz
CS setup time			

### I<sup>2</sup>C - inter IC control interface

Subject to general operating conditions for Vdd and Top.

#### I<sup>2</sup>C slave timing values

Parameter	I <sup>2</sup> C standard mode (1)		I <sup>2</sup> C fast mode (1)		Unit
	Min.	Max.	Min.	Max.	
SCL clock frequency	0	100	0	400	kHz

Table 7. Absolute maximum ratings

Symbol	Ratings	Maximum value	Unit
Vdd	Supply voltage	-0.3 to 4.8	V

### Application hints

Figure 5. LIS3DSH electrical connection

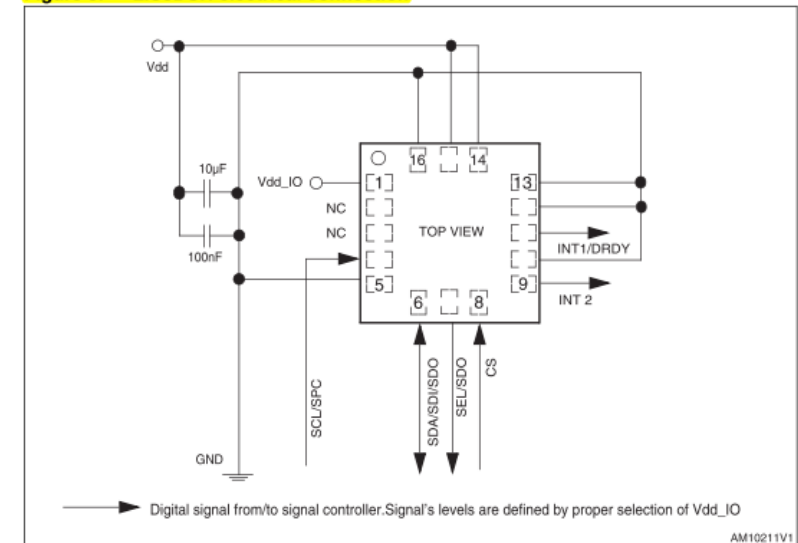

### VP 6 - STM32 CubeIDE, SPI in LIS3DSH

### Gradiva

Figure 6. Read and write protocol

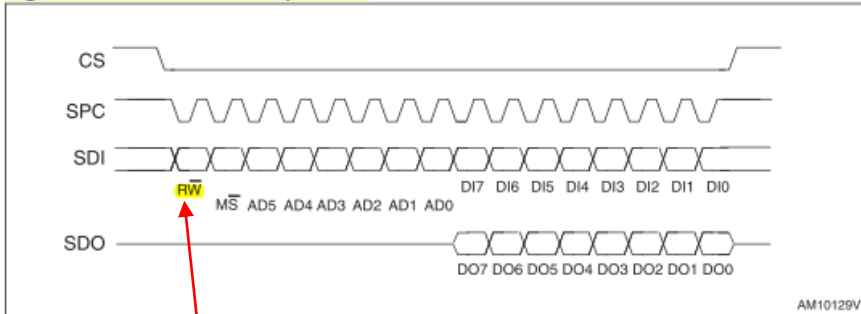

**bit 0: RW bit:** When 0, the data DI(7:0) is written into the device. When 1, the data DO(7:0) from the device is read. In the latter case, the chip drives **SDO** at the start of bit 8.

**bit 1-7: address AD(6:0):** This is the address field of the indexed register.

**bit 8-15: data DI(7:0) (write mode):** This is the data that is written into the device (MSb first).

**bit 8-15: data DO(7:0) (read mode):** This is the data that is read from the device (MSb first).

### 8.3 WHO\_AM\_I (0Fh)

Who\_AM\_I register.



Table 19. WHO\_AM\_I register default value

0	0	1	1	1	1	1	1
---	---	---	---	---	---	---	---

```
// Config accelerometer
// Read WHOAMI register
HAL_GPIO_WritePin(GPIOE, GPIO_PIN_3, GPIO_PIN_RESET);
outdata[0] = 0x0f | 0x80 ; // read whoami
HAL_SPI_TransmitReceive(&hspi1, &outdata, &indata, 2, HAL_MAX_DELAY);
lis_id = indata[1];
HAL_GPIO_WritePin(GPIOE, GPIO_PIN_3, GPIO_PIN_SET);

// Write to CTRL register (enable 3 axes measurements on 25Hz)
HAL_GPIO_WritePin(GPIOE, GPIO_PIN_3, GPIO_PIN_RESET);
outdata[0] = 0x20 ; // switch on axes
outdata[1] = 0x47 ;
HAL_SPI_TransmitReceive(&hspi1, &outdata, &indata, 2, HAL_MAX_DELAY);
HAL_GPIO_WritePin(GPIOE, GPIO_PIN_3, GPIO_PIN_SET);
```

SPI slave timing values

id	Parameter	Value (1)		Unit
		Min.	Max.	
1)	SPI clock cycle	100		ns
2)	SPI clock frequency		10	MHz
3)	CS setup time	6		ns

Table 7. Absolute maximum ratings

Symbol	Ratings	Maximum value	Unit
Vdd	Supply voltage	-0.3 to 4.8	V

### 8.5 CTRL\_REG4 (20h)

Control register 4.

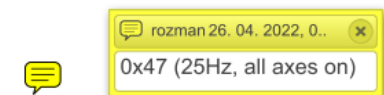

Table 22. Control register 4

ODR3	ODR2	ODR1	ODR0	BDU	ZEN	YEN	XEN
------	------	------	------	-----	-----	-----	-----

Table 23. CTRL\_REG4 register description

ODR3:0	Output data rate and power mode selection. Default value:0000 (see Table 24)
BDU	Block data update. Default value:0 0=continuous update; 1=output registers not updated until MSB and LSB reading)
Zen	Z axis enable. Default value:1 (0:Z axis disabled; 1:Z axis enabled)
Yen	Y axis enable. Default value:1 (0:Y axis disabled; 1:Y axis enabled)
Xen	X axis enable. Default value:1 (0=X axis disabled; 1=X axis enabled)

Table 24. CTRL4 ODR configuration

ODR3	ODR2	ODR1	ODR0	ODR selection
0	0	0	0	Power down
0	0	0	1	3.125 Hz
0	0	1	0	6.25 Hz
0	0	1	1	12.5 Hz
0	1	0	0	25 Hz

Figure 6. Read and write protocol

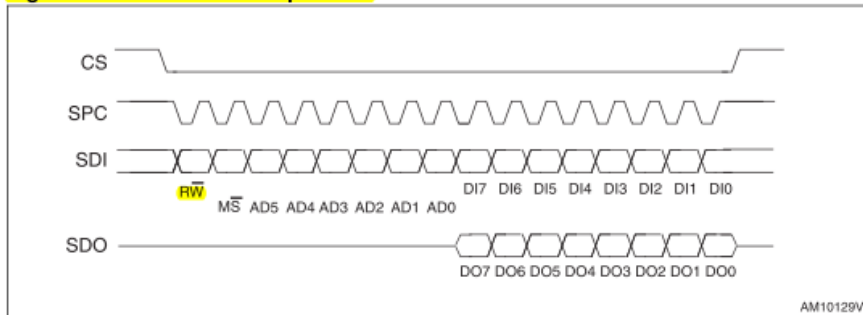

**bit 0: RW bit.** When 0, the data DI(7:0) is written into the device. When 1, the data DO(7:0) from the device is read. In the latter case, the chip drives **SDO** at the start of bit 8.

**bit 1-7: address AD(6:0).** This is the address field of the indexed register.

**bit 8-15: data DI(7:0) (write mode).** This is the data that is written into the device (MSb first).

**bit 8-15: data DO(7:0) (read mode).** This is the data that is read from the device (MSb first).

```
// Read x,y,z axes
```

```
outdata[0] = 0x29 | 0x80 ; // read x
HAL_GPIO_WritePin(GPIOE, GPIO_PIN_3, GPIO_PIN_RESET);
HAL_SPI_TransmitReceive(&hspi1, &outdata, &indata, 2, HAL_MAX_DELAY);
AccelX = indata[1];
```

```
outdata[0] = 0x2B | 0x80 ; // read y
HAL_SPI_TransmitReceive(&hspi1, &outdata, &indata, 2, HAL_MAX_DELAY);
AccelY = indata[1];
```

```
outdata[0] = 0x2D | 0x80 ; // read z
HAL_SPI_TransmitReceive(&hspi1, &outdata, &indata, 2, HAL_MAX_DELAY);
HAL_GPIO_WritePin(GPIOE, GPIO_PIN_3, GPIO_PIN_SET);
AccelZ = indata[1];
```

## 7 Register mapping

Table 16 provides a list of the 8/16-bit registers embedded in the device and the related address:

Table 16. Register address map

Name	Type	Register address		Default	Comment
		Hex	Binary		
INFO1	r	0D	00001101	0010 0001	Information register 1
INFO2	r	0E	00001110	0000 0000	Information register 2
WHO_AM_I	r	0F	00001111	0011 1111	Who I am ID
OUT_X_L	r	28	00101000	0000 0000	Output registers
OUT_X_H	r	29	00101001		
OUT_Y_L	r	2A	00101010		
OUT_Y_H	r	2B	00101011		
OUT_Z_L	r	2C	00101100		
OUT_Z_H	r	2D	00101101		

### 8.23 OUT\_X (28h - 29h)

X-axis output register.

Table 49. OUT\_X\_L register default value

0	0	0	0	0	0	0	0	0
---	---	---	---	---	---	---	---	---

Table 50. OUT\_X\_H register default value

0	0	0	0	0	0	0	0	0
---	---	---	---	---	---	---	---	---

## Spremenljivke

main.c : dodana koda

## Glavna zanka

```

/* Infinite loop */
/* USER CODE BEGIN WHILE */
while (1)
{
// Read x,y,z axes
outdata[0] = 0x29 | 0x80 ; // read x
HAL_GPIO_WritePin(GPIOE, GPIO_PIN_3, GPIO_PIN_RESET);
HAL_SPI_TransmitReceive(&hspi1, &outdata, &indata, 2, HAL_MAX_DELAY);
AccelX = indata[1];

outdata[0] = 0x2B | 0x80 ; // read y
HAL_SPI_TransmitReceive(&hspi1, &outdata, &indata, 2, HAL_MAX_DELAY);
AccelY = indata[1];

outdata[0] = 0x2D | 0x80 ; // read z
HAL_SPI_TransmitReceive(&hspi1, &outdata, &indata, 2, HAL_MAX_DELAY);
HAL_GPIO_WritePin(GPIOE, GPIO_PIN_3, GPIO_PIN_SET);
AccelZ = indata[1];

...

sprintf(SendBuffer, BUFSIZE, "Hello World [%d]: Key:%d Duty:%d PWM-Freq:%d PWM-Period:%d
Accel[ID:%02x] X:%04d Y:%d
Z:%04d\r\n", Counter++, KeyState, Duty, NoteFreq, NotePeriod, lis_id, AccelX, AccelY, AccelZ);
CDC_Transmit_FS(SendBuffer, strlen(SendBuffer));

/* USER CODE END WHILE */

```

## Inicializacija

```

/* USER CODE BEGIN PV */
#define BUFSIZE 256
char SendBuffer[BUFSIZE];
int Counter;
int KeyState=0;

// Global variables
uint8_t indata[2];
uint8_t outdata[2] = {0,0};
uint8_t lis_id;
int8_t AccelX;
int8_t AccelY;
int8_t AccelZ;

HAL_StatusTypeDef SPIStatus;

/* USER CODE END PV */

/* USER CODE BEGIN 2 */

// Config accelerometer
// Read WHOAMI register
HAL_GPIO_WritePin(GPIOE, GPIO_PIN_3, GPIO_PIN_RESET);
outdata[0] = 0x0f | 0x80 ; // read whoami
HAL_SPI_TransmitReceive(&hspi1, &outdata, &indata, 2,
HAL_MAX_DELAY);
lis_id = indata[1];
HAL_GPIO_WritePin(GPIOE, GPIO_PIN_3, GPIO_PIN_SET);

HAL_Delay(500);

// Set CTRL register 0x47 -> [0x20]
HAL_GPIO_WritePin(GPIOE, GPIO_PIN_3, GPIO_PIN_RESET);
outdata[0] = 0x20 ; // switch on axes
outdata[1] = 0x47 ;
HAL_SPI_TransmitReceive(&hspi1, &outdata, &indata, 2,
HAL_MAX_DELAY);
HAL_GPIO_WritePin(GPIOE, GPIO_PIN_3, GPIO_PIN_SET);

HAL_Delay(500);
outdata[1] = 0x00 ;

/* USER CODE END 2 */

```

[https://github.com/LAPSyLAB/STM32F4\\_Discovery\\_VIN\\_Projects/tree/main/STM32\\_SPI\\_LIS302DL\\_Basic](https://github.com/LAPSyLAB/STM32F4_Discovery_VIN_Projects/tree/main/STM32_SPI_LIS302DL_Basic)

SCK

MOSI

MISO

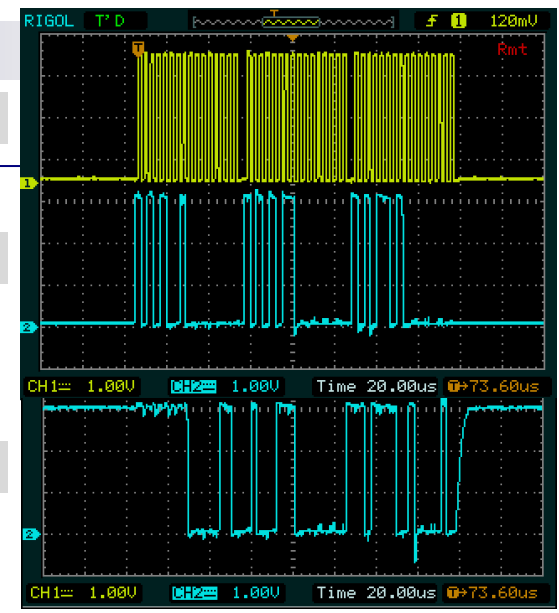
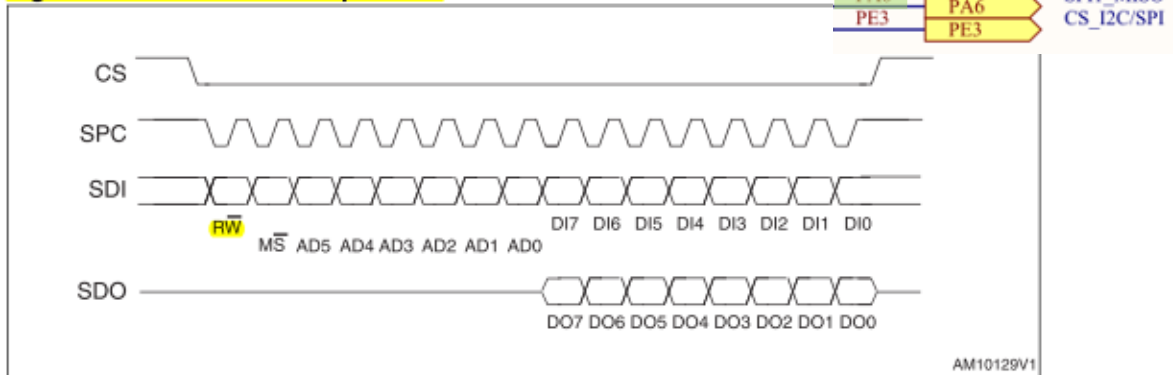

Figure 6. Read and write protocol



```
Hello World [3530]: Key:0000 Accel[ID:00] X:0005 Y:-1 Z:0066
Hello World [3531]: Key:0000 Accel[ID:00] X:0005 Y:-1 Z:0067
```

X-Accel: 5

Y-Accel: -1

Y-Accel: 67

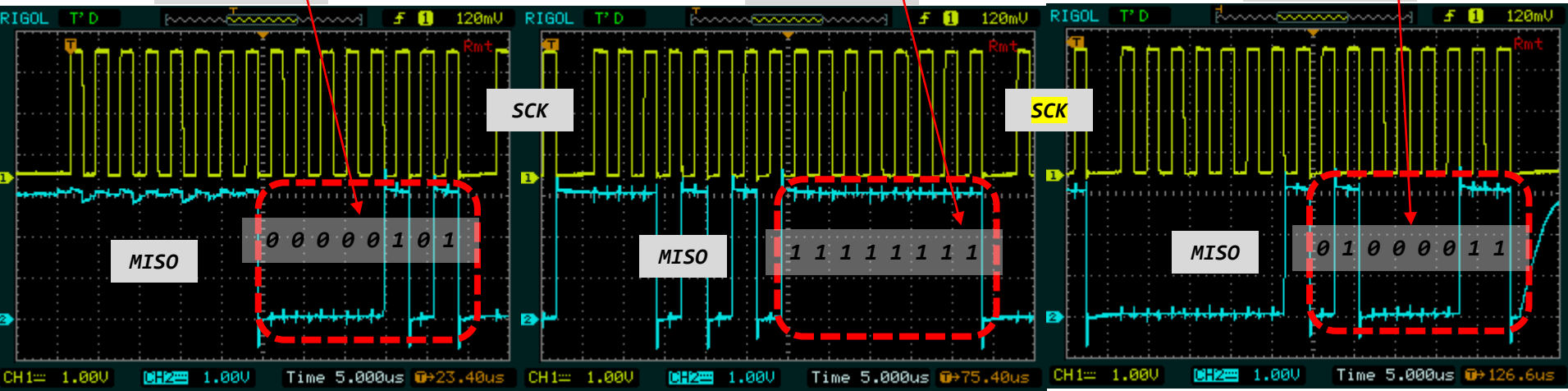

Določite bitno hitrost prenosa in ugotovite vsebino signala SPI2 z nastavitvami: CPOL=0, CPHA=0, komunikacija z napravo LIS3DSH, ...

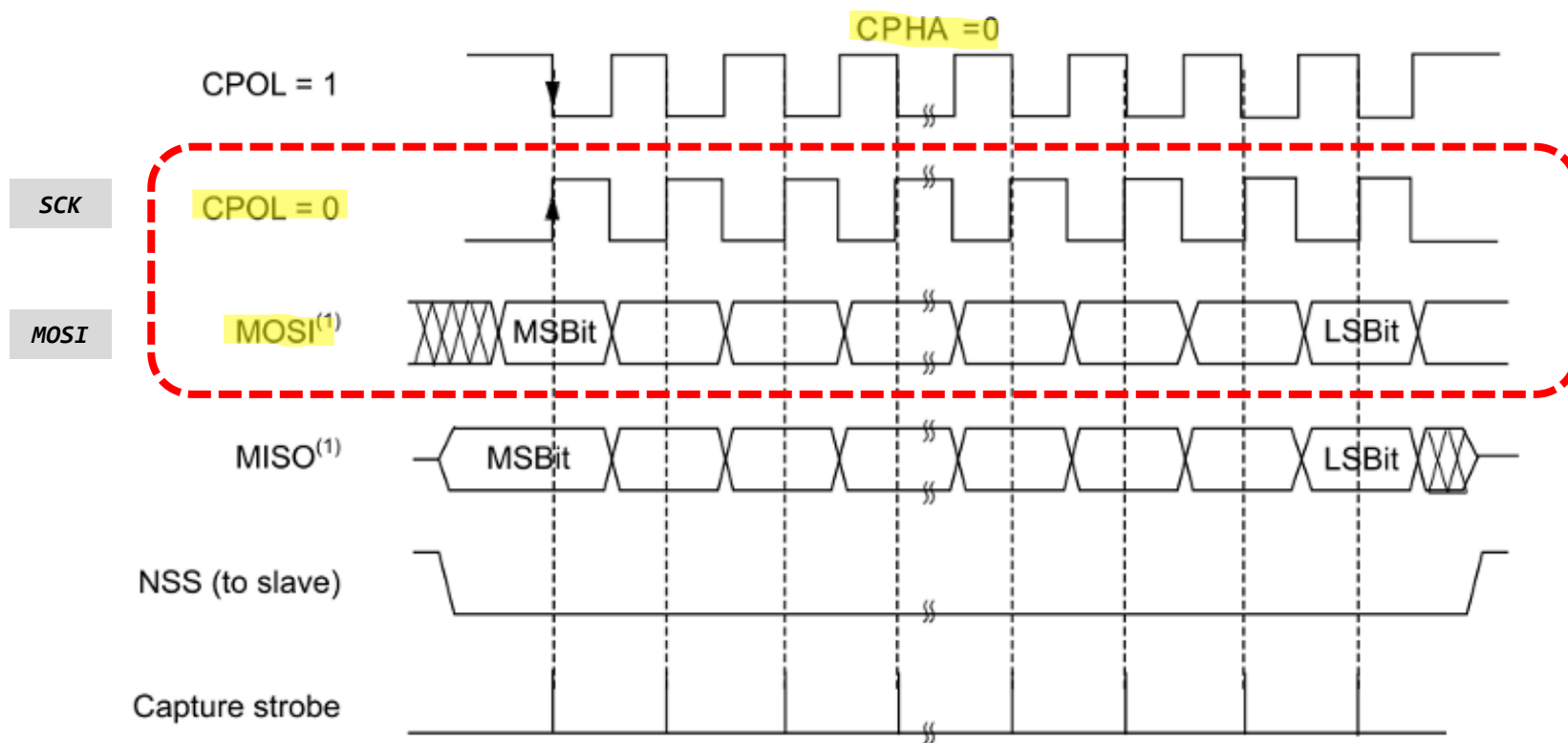

# Laboratorijska vaja 12

## Tipala in signali – praktični izzivi

- 12a: LV5a : Tipala in signali – meritve
  - a) Meritev karakteristične upornosti linije z multimetrom ( $R_0$ )
  - b) Preizkusi različnih tipal (IR,UZ razdalja, PIR, Hall, ...)
  - c) Meritve deformacij UTP kabla
  - d) \*LV2-4 - Presluh – meritve na ploščatem kablu
  
- 12b: LV5b : STM32H7 – Generator signalov
  - a) UART                      PB14
  - b) PWM                        PA3
  - c) SPI                          PD3(SCK),      PI3 (MOSI)
  - d) I2C                          PD12(SCL), PD13(SDA)
  - e) CANBUS                    CN1 (FDCAN1: CAN-L, CAN-H)

## □ Signali na linijah

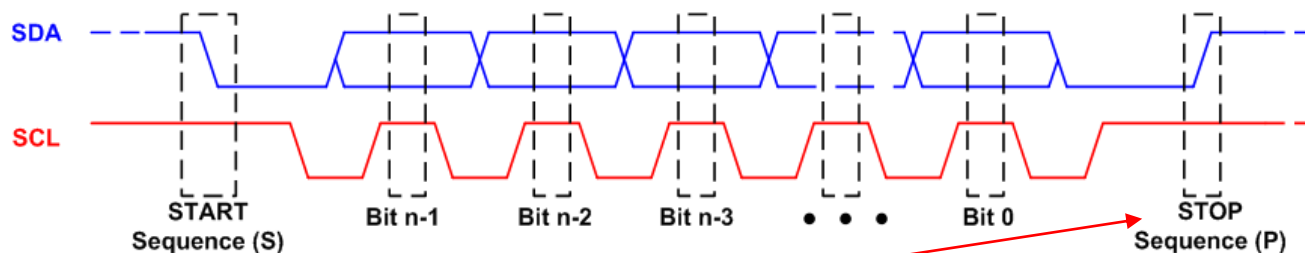

### ▪ Dodatna bita (vedno generira master) :

- pogoj **start** – linija SDA preklopi iz 1 v 0 preden linija SCL preklopi iz 1 v 0
- pogoj **stop** - linija SDA preklopi iz 0 v 1 potem ko linija SCL preklopi iz 0 v 1

## □ Primer komunikacije

start	Naslovni okvir	read / write	ACK / NACK	Podatkovni okvir	ACK / NACK	Podatkovni okvir	ACK / NACK	stop
-------	----------------	--------------	------------	------------------	------------	------------------	------------	------

### ▪ Dodatni biti:

- **read/write** – en bit določa prenos iz 'master' v 'slave' napravo (0) ali 'master' zahteva podatek iz 'slave' naprave (1).
- **ACK/NACK** – vsak okvir sporočila ima bit 'acknowledge/noacknowledge'. Če je bil naslovni ali podatkovni okvir uspešno prejet je pošiljatelju vrnjen bit ACK, sicer NACK.



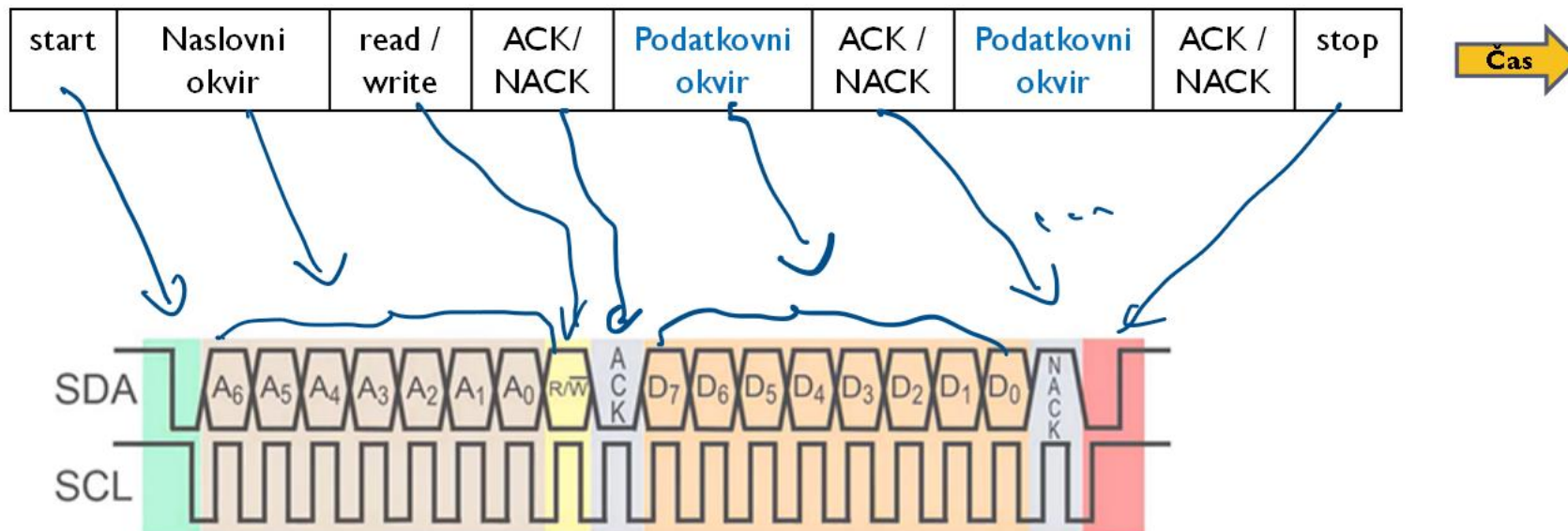

Dodatni biti med okvirji:

- **read/write** – en bit določa prenos iz 'master' v 'slave' napravo (0) ali 'master' zahteva podatek iz 'slave' naprave (1).
- **ACK/NACK** – vsak okvir sporočila ima bit 'acknowledge/noacknowledge'. Če je bil naslovni ali podatkovni okvir uspešno prejet je pošiljatelju vrnjen bit ACK, sicer NACK.
  - **start** – linija SDA preklopi iz 1 v 0 preden linija SCL preklopi iz 1 v 0
  - **stop** - linija SDA preklopi iz 0 v 1 potem ko linija SCL preklopi iz 0 v 1

# Primer I2C komunikacije STM32H7 - Touch

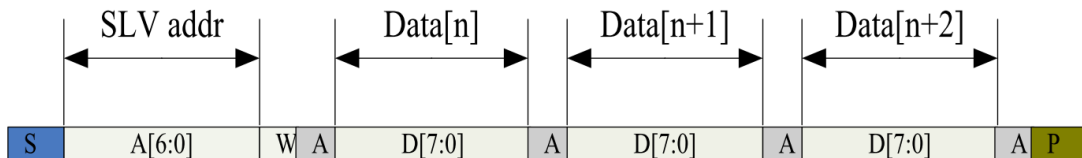

Figure 2-5 I2C master write, slave read

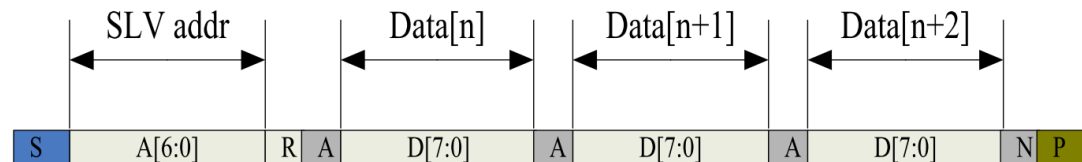

Figure 2-6 I2C master read, slave write

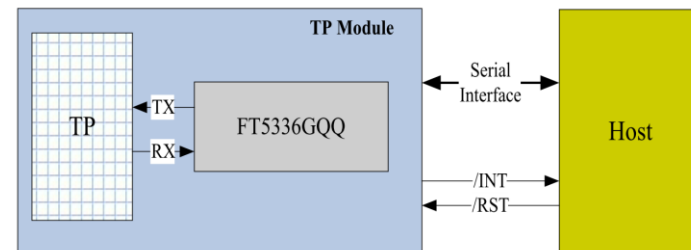

Figure 2-3 Host Interface Diagram

[https://github.com/LAPSyLAB/STM32H7\\_Discovery\\_VIN\\_Projects/tree/main/STM32H750B-DK\\_I2C\\_Touch\\_Demo](https://github.com/LAPSyLAB/STM32H7_Discovery_VIN_Projects/tree/main/STM32H750B-DK_I2C_Touch_Demo)

## 8-bitni naslovi in registri

### Work Mode Register Map

Address	Name	Bit7	Bit6	Bit5	Bit4	Bit3	Bit2	Bit1	Bit0	Host Access	
00h	DEVIDE_MODE	Device Mode[2:0]								RW	
01h	GEST_ID	Gesture ID[7:0]									R
02h	TD_STATUS					Number of touch points[3:0]				R	
03h	TOUCH1_XH	1 <sup>st</sup> Event Flag			1 <sup>st</sup> Touch X Position[11:8]					R	
04h	TOUCH1_XL	1 <sup>st</sup> Touch X Position[7:0]									R
05h	TOUCH1_YH	1 <sup>st</sup> Touch ID[3:0]			1 <sup>st</sup> Touch Y Position[11:8]					R	
06h	TOUCH1_YL	1 <sup>st</sup> Touch Y Position[7:0]									R
A8h	ID_G_FT5201ID	CTPM Vendor ID									R

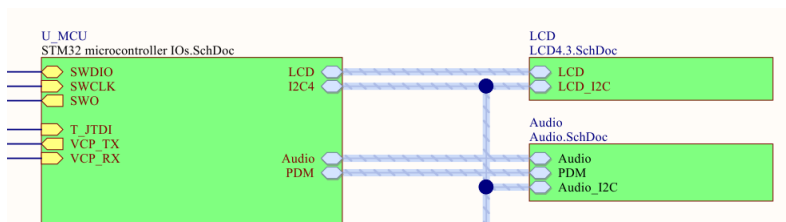

# Primer I2C komunikacije

## STM32H7 - Touch

```
// Reading from address 0x38 register Vendor's Chip ID (addr. 0xA8) default value should be 0x51=81
```

```
retval = HAL_I2C_Mem_Read(&hi2c4, (0x38 << 1), 0xA8, I2C_MEMADD_SIZE_8BIT, &VendorID, 1, HAL_MAX_DELAY);

retval = HAL_I2C_Mem_Read(&hi2c4, (0x38 << 1), 0x00, I2C_MEMADD_SIZE_8BIT, &DeviceMode, 1, HAL_MAX_DELAY);
retval = HAL_I2C_Mem_Read(&hi2c4, (0x38 << 1), 0x01, I2C_MEMADD_SIZE_8BIT, &Gesture, 1, HAL_MAX_DELAY);
retval = HAL_I2C_Mem_Read(&hi2c4, (0x38 << 1), 0x02, I2C_MEMADD_SIZE_8BIT, &Status, 1, HAL_MAX_DELAY);

retval = HAL_I2C_Mem_Read(&hi2c4, (0x38 << 1), 0x03, I2C_MEMADD_SIZE_8BIT, &dataBuffer, 5, HAL_MAX_DELAY);
if (Status != 0) {
    TouchX = ((dataBuffer[0] & 0b1111) << 8) + dataBuffer[1];
    TouchY = ((dataBuffer[2] & 0b1111) << 8) + dataBuffer[3];
} else {
    TouchX = 0;
    TouchY = 0;
}
```

### 8-bitni naslovi in registri

Work Mode Register Map

Address	Name	Bit7	Bit6	Bit5	Bit4	Bit3	Bit2	Bit1	Bit0	Host Access
00h	DEVIDE_MODE	Device Mode[2:0]								RW
01h	GEST_ID	Gesture ID[7:0]								R
02h	TD_STATUS					Number of touch points[3:0]				R
03h	TOUCH1_XH	1 <sup>st</sup> Event Flag					1 <sup>st</sup> Touch X Position[11:8]			R
04h	TOUCH1_XL	1 <sup>st</sup> Touch X Position[7:0]								R
05h	TOUCH1_YH	1 <sup>st</sup> Touch ID[3:0]				1 <sup>st</sup> Touch Y Position[11:8]				R
06h	TOUCH1_YL	1 <sup>st</sup> Touch Y Position[7:0]								R
A8h	ID_G_FT520IID	CTPM Vendor ID								R

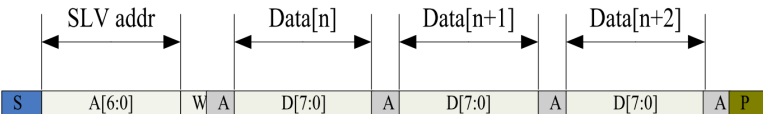

Figure 2-5 I2C master write, slave read

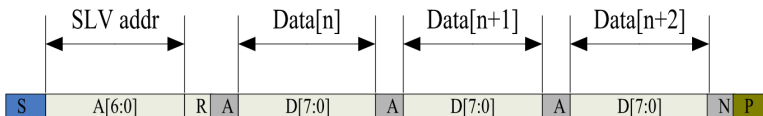
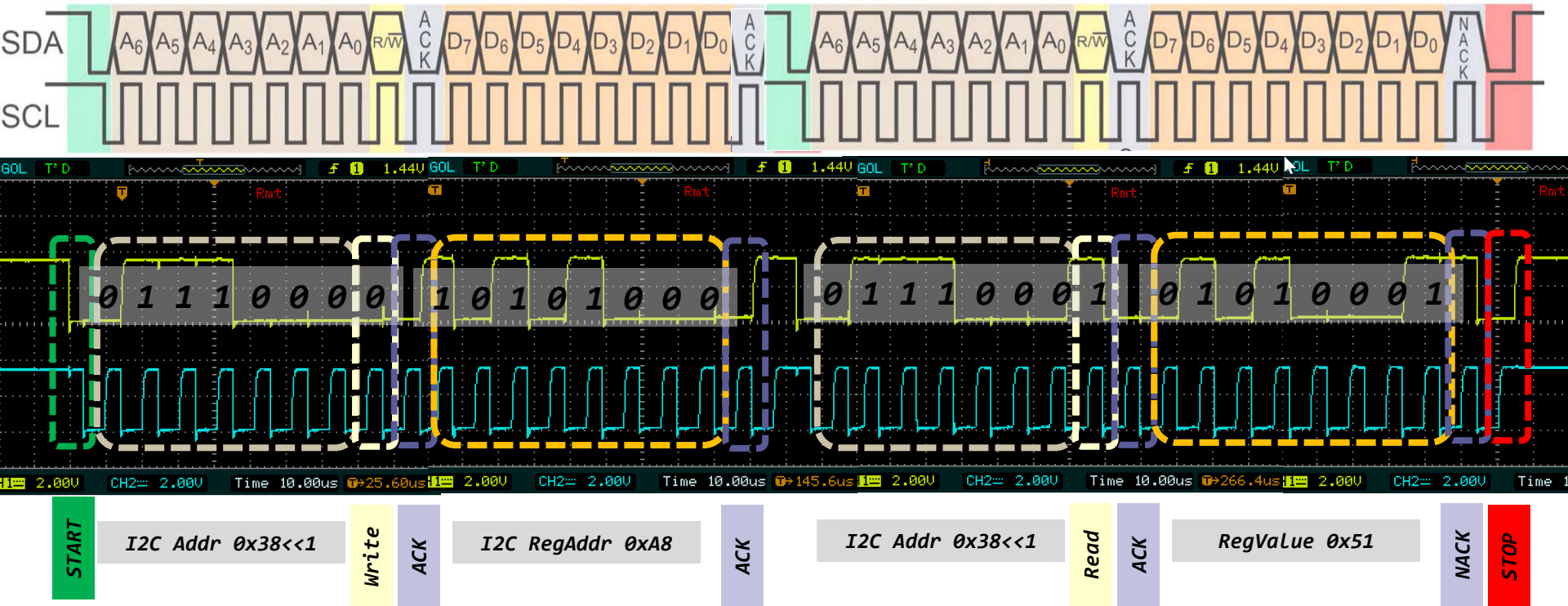

Figure 2-6 I2C master read, slave write

# Primer I2C komunikacije STM32H7 - Touch

I2C branje

```
// Reading from address 0x38 register Vendor's Chip ID (addr. 0xA8) default value should be 0x51=81
retval = HAL_I2C_Mem_Read(&hi2c4, (0x38 << 1), 0xA8, I2C_MEMADD_SIZE_8BIT,&dataBuffer[5], 1, HAL_MAX_DELAY);
```



[https://github.com/LAPSYLAB/STM32H7\\_Discovery\\_VIN\\_Projects/tree/main/STM32H750B-DK\\_I2C\\_Basic\\_Demo](https://github.com/LAPSYLAB/STM32H7_Discovery_VIN_Projects/tree/main/STM32H750B-DK_I2C_Basic_Demo)

# Primer I2C komunikacije STM32H7 - Audio

The sequence of signals associated with a single register write operation is illustrated in Figure 72.

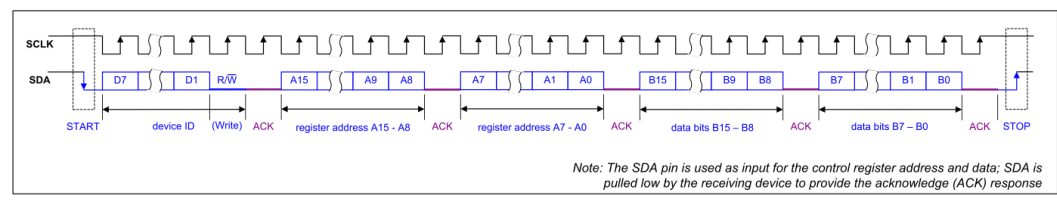

Figure 72 Control Interface 2-wire (I2C) Register Write

The sequence of signals associated with a single register read operation is illustrated in Figure 73.

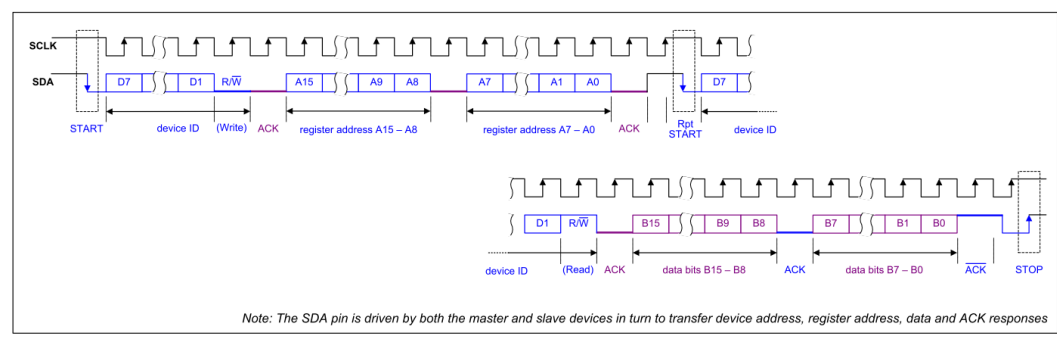

Figure 73 Control Interface 2-wire (I2C) Register Read

## REGISTER MAP

The WM8994 control registers are listed below. Note that only the register addresses described here should be accessed; writing to other addresses may result in undefined behaviour. Register bits that are not documented should not be changed from the default values.

REG	NAME	15	14	13	12	11	10	9	8	7	6	5	4	3	2	1	0	DEFAULT
R0 (0h)	Software Reset	SW_RESET [15:0]																0000h
R1 (1h)	Power Management (1)	0	0	SPKO UTL_E NA	SPKO UTL_E NA	HPOU T2_EN A	0	HPOU T1L_E NA	HPOU T1R_E NA	0	0	MICB2 _ENA	MICB1 _ENA	0	VMID_SEL [1:0]		BIAS_ ENA	0000h
R2 (2h)	Power Management (2)	0	TSHUT _ENA	TSHUT _OPDI S	0	OPCLK _ENA	0	MIXINL _ENA	MIXIN R_ENA	IN2L_E NA	IN1L_E NA	IN2R_ ENA	IN1R_ ENA	0	0	0	0	6000h

## Multi-channel Audio Hub CODEC for Smartphones

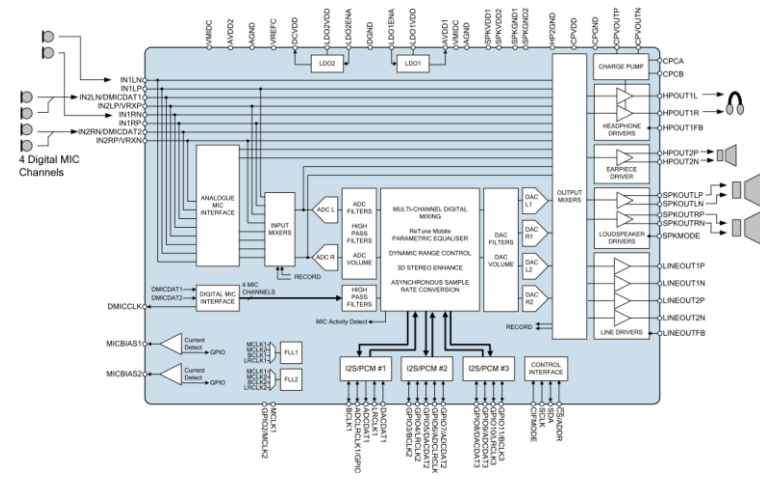

[https://github.com/LAPSYLAB/STM32H7\\_Discovery\\_VIN\\_Projcts/tree/main/STM32H750B-DK\\_I2C\\_Basic\\_Demo](https://github.com/LAPSYLAB/STM32H7_Discovery_VIN_Projcts/tree/main/STM32H750B-DK_I2C_Basic_Demo)

16-bitni naslovi in registri

# Primer I2C komunikacije STM32H7 - Audio

Multi-channel Audio Hub CODEC for Smartphones

16-bitni naslovi in registri

```
// Reading from device address 0x1a register R0 (addr. 0x00) default value should be 0x8994
dataBuffer[0] = 0; dataBuffer[1] = 0x00;
retval = HAL_I2C_Master_Transmit(&hi2c4, (0x1a << 1), dataBuffer, 2, HAL_MAX_DELAY);

retval = HAL_I2C_Master_Receive(&hi2c4, (0x1a << 1), dataBuffer, 2, HAL_MAX_DELAY);

sprintf(SendBuffer, BUFSIZE, "Hello World [%d]: Key:%d Reg.value1:0x%\n\r", Counter++, KeyState,
dataBuffer[0]*256+dataBuffer[1]);

HAL_UART_Transmit(&huart3, SendBuffer, strlen(SendBuffer), 100);
```

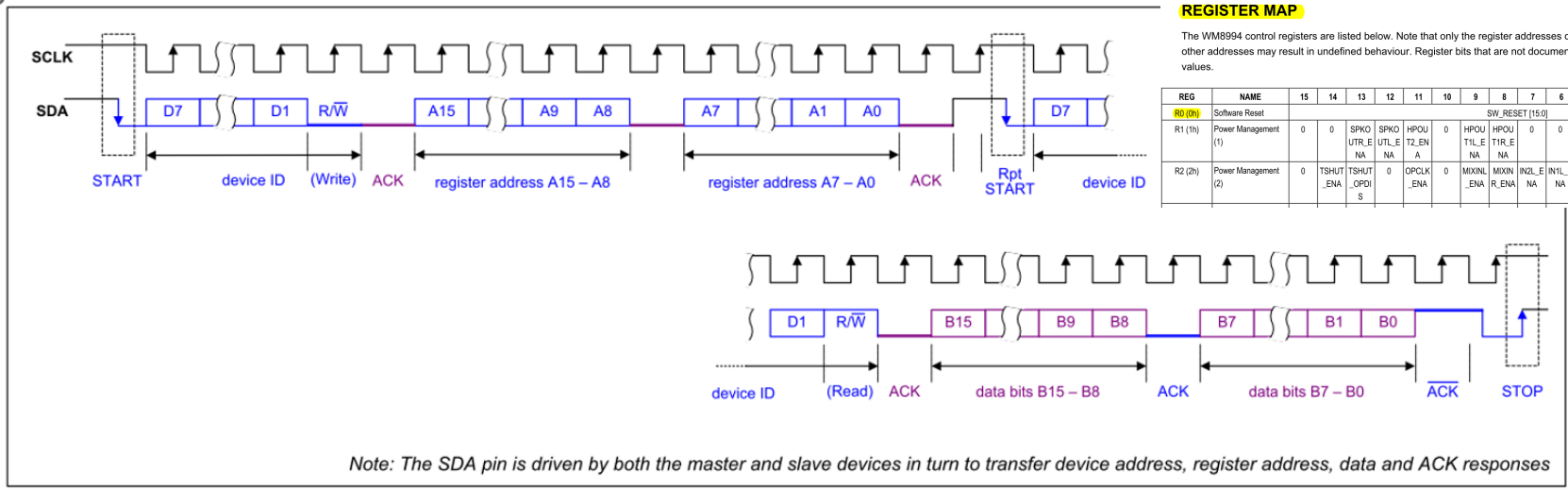

### REGISTER MAP

The WM8994 control registers are listed below. Note that only the register addresses described here should be accessed; writing to other addresses may result in undefined behaviour. Register bits that are not documented should not be changed from the default values.

REG	NAME	15	14	13	12	11	10	9	8	7	6	5	4	3	2	1	0	DEFAULT
R0 (0h)	Software Reset	SW_RESET [15:0]																0000h
R1 (1h)	Power Management (1)	0	0	SPKO_UTR_EN	SPKO_UTL_EN	HPOU_TZ_EN	0	HPOU_T1L_EN	HPOU_T1R_EN	0	0	MICB2_ENA	MICB1_ENA	0	VMIID_SEL [1:0]	BIAS_ENA	0000h	
R2 (2h)	Power Management (2)	0	TSHUT_ENA	TSHUT_OPDIS	0	OPCLK_ENA	0	MIXNL_ENA	MIXIN_R_ENA	IN2L_ENA	IN1L_ENA	IN2R_ENA	IN1R_ENA	0	0	0	0	6000h

Note: The SDA pin is driven by both the master and slave devices in turn to transfer device address, register address, data and ACK responses

Figure 73 Control Interface 2-wire (I2C) Register Read

[https://github.com/LAPSYLAB/STM32H7\\_Discovery\\_VIN\\_Projects/tree/main/STM32H750B-DK\\_I2C\\_Basic\\_Demo](https://github.com/LAPSYLAB/STM32H7_Discovery_VIN_Projects/tree/main/STM32H750B-DK_I2C_Basic_Demo)

Določite **bitno hitrost** prenosa in ugotovite **vsebino signala I2C4**:

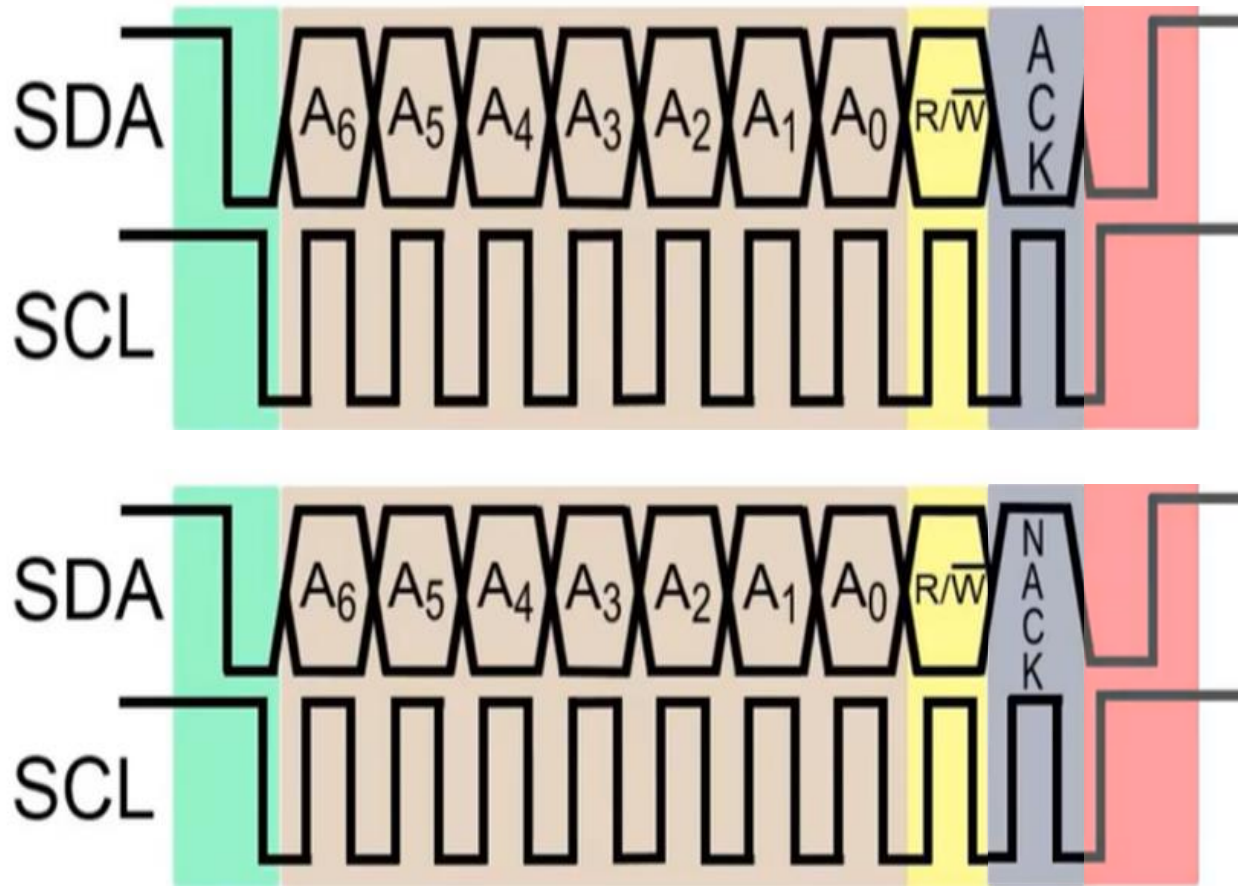

# Laboratorijska vaja 12

## Tipala in signali – praktični izzivi

- 12a: LV5a : Tipala in signali – meritve
  - a) Meritev karakteristične upornosti linije z multimetrom ( $R_0$ )
  - b) Preizkusi različnih tipal (IR,UZ razdalja, PIR, Hall, ...)
  - c) Meritve deformacij UTP kabla
  - d) \*LV2-4 - Presluh – meritve na ploščatem kablu
  
- 12b: LV5b : STM32H7 – Generator signalov
  - a) UART                      PB14
  - b) PWM                        PA3
  - c) SPI                         PD3(SCK),        PI3 (MOSI)
  - d) I2C                         PD12(SCL), PD13(SDA)
  - e) CANBUS                    CN1 (FDCAN1: CAN-L, CAN-H)



# CANbus napetostni nivoji ISO-IS 11898

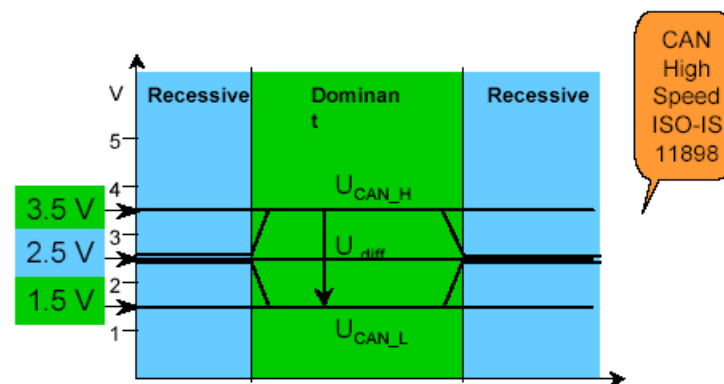

## •Recesivni bit „1“:

- obe liniji na približno 2.5V
- diferencialna napetost CAN\_H in CAN\_L  $\approx 0$  V

## •Dominantni bit „0“:

- CAN\_H na pribl. 3.5 V in CAN\_L pribl. 1.5 V
- diferencialna napetost CAN\_H in CAN\_L  $\approx 2$  V

# Format sporočila

- Vsako sporočilo ima ID, podatke in dodatke
- ID - 11 ali 29 bitov
- Data - do 8 bajtov
- Dodatki - start (SOF), CRC, ACK, end (EOF)

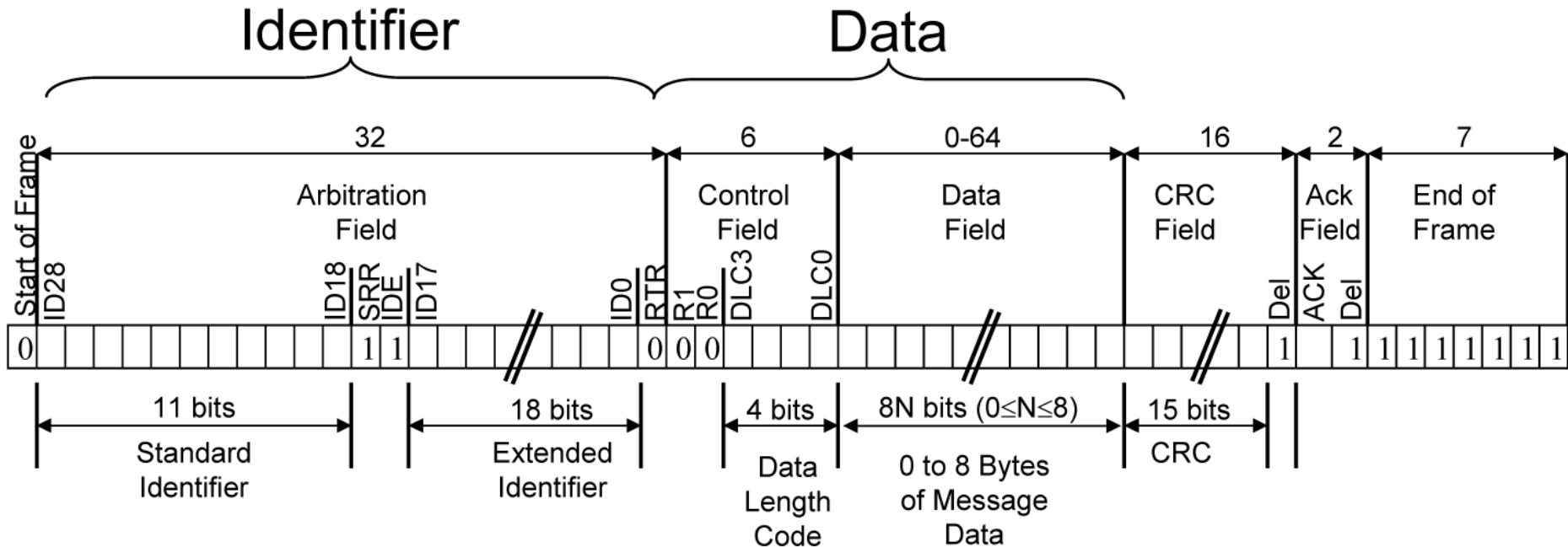



Določite bitno hitrost prenosa in določite vsebino signala CANBUS, ki se prenaša ob nastavitvah: 11b ID = 0x555, 2 bajta 0xCC, bit-stuff (po 5 enakih bitih), ...

Recesivni bit „1“:

- obe liniji na približno 2.5V
- Dominantni bit „0“:
- CAN\_H na pribl. 3.5 V in CAN\_L pribl. 1.5 V

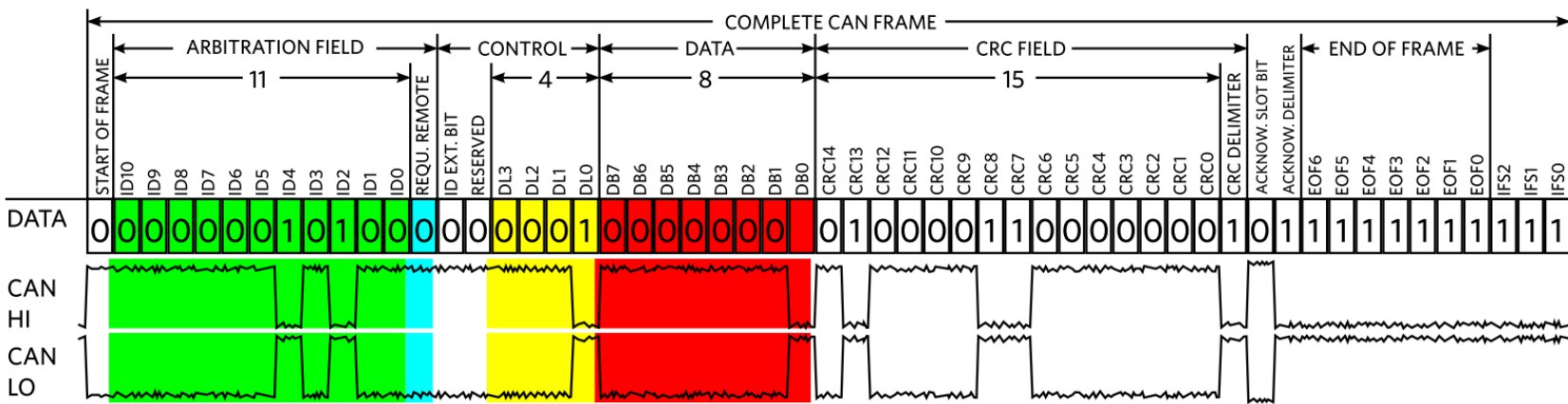
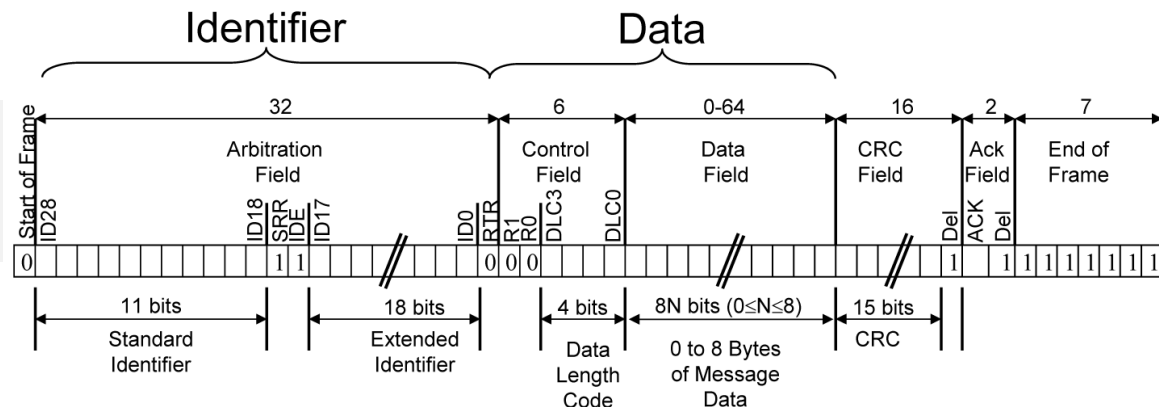

Figure 4. CAN Message Data-Frame Format

# Tipala in signali – praktični izzivi – DN2-LV5\*

- Spada v sklop poročila z LAB vaj
- Opišite reševanje izzivov po lastni izbiri
- Objavite v OneNote delovnem zvezku
- \_Prostor za sodelovanje, razdelek DN2-LV5 Izzivi

VIN-VSP 202324 zvezek ▾  
\_Collaboration Space

Uporaba prostora za sodelovanje DN1-VI naprave • DN2-VP1 TinkerCad • DN2-LV5 Izzivi ▾ +

## Preberi.me

sreda, 16. marec 2022 18:09

Tukaj objavite svoje rešitve izzivov:

- Naredite svojo stran z naslovom rešitve
- Par stavkov opisa, slika in razlaga
- Rešitev shranite v svojem zvezku za vključitev v DN2 poročilo z laboratorijskih vaj (naloga DN2-LV5)

RR

# Tipala in signali – praktični izzivi – DN2-LV5\*

## LV5 Meritve tipal in signalov (PWM,I2C,SPI,UART)

Izberite in rešite čimveč izzivov in ustrezno dokumentirajte postopke.

### LV5a: Izzivi LV1-LV4

#### Neobvezni izzivi

- Meritve karakteristične upornosti linije z multimetrom (R0)
- Preizkusi različnih tipal (IR,UZ razdalja, PIR, Hall, ...)
- Meritve deformacij UTP kabla
- \*LV2-4 - Presluh – meritve na ploščatem kablu

#### \*LV4-3 IEX Modul na STM32H7

Dopolnite osnovni program za IEX modul na STM32H7 vsaj s sprejemom QX sporočil in oddajo IX sporočil, da se bo na modulu lahko uporabilo tudi tipke in LED diode. Program lahko razširite še na PWM izhoda in ADC vhoda.

### LV5b Meritve signalov – STM32H7 Signal generator - izziv

#### Neobvezni izzivi

- |           |                           |
|-----------|---------------------------|
| a) UART   | PB14                      |
| b) PWM    | PA3                       |
| c) SPI    | PD3(SCK), PI3 (MOSI)      |
| d) I2C    | PD12(SCL), PD13(SDA)      |
| e) CANBUS | CN1 (FDCAN1:CAN-L, CAN-H) |

#### Meritve UART signala

Določite bitno hitrost in znak(e), ki se prenašajo po UART TTL povezavi.

#### Meritve PWM signala

Določite periodo, frekvenco PWM signala in ustrezno glasbeno noto.

#### Meritve SPI signala

Določite bitno hitrost prenosa in ugotovite vsebino signala SPI2 z nastavitvami: CPOL=0, CPHA=0, naprava LIS3DSH, ...

#### Meritve I2C signala

Določite bitno hitrost prenosa in ugotovite vsebino signala I2C4.

#### Meritve CANBUS signala

Določite bitno hitrost prenosa in določite vsebino signala CANBUS, ki se prenaša ob nastavitvah: 11b ID = 0x555, 2 bajta 0xCC, bit-stuff (po 5 enakih bitih), ...