

Discovery kits with STM32H745XI and STM32H750XB microcontrollers

Introduction

The STM32H745I-DISCO and STM32H750B-DK Discovery kits are complete demonstration and development platforms for STMicroelectronics Arm® Cortex®-M7 and -M4 dual-core-based STM32H745XI (STM32H745XI6 order code) and STM32H750XB (STM32H750XBH6 order code) microcontrollers. Both devices feature four I²Cs, six SPIs with three multiplexed simplex I²Ss, two SD/SDIO/DMMC interfaces, four USARTs, four UARTs, one LPUART, two CAN controllers, three 16-bit ADCs, two 12-bit DACs, four SAIs, 8- to 14-bit digital camera interface, 1 Mbyte (STM32H745XI6) or 128 Kbytes (STM32H750XBH6) of internal SRAM and 2 Mbytes of Flash memory, a USB OTG HS and a USB OTG FS, an Ethernet MAC interface, an FMC interface, a Quad-SPI interface, and SWD debugging support. The STM32H745I-DISCO and STM32H750B-DK Discovery kits enable users to quickly get started and develop applications.

In addition, the STM32H745I-DISCO and STM32H750B-DK, shown in Figure 1 and Figure 2, can be used as a reference design for user application prototyping before porting to the final product.

The full range of hardware features available on the board helps users improve application development by an evaluation of almost all peripherals (such as USB OTG FS, Ethernet 10/100Mb/s, eMMC, USART, SAI Audio DAC stereo with audio jack input and output, MEMS digital microphone, SDRAM, Quad-SPI Flash memory, and RGB LCD interface with capacitive multi-touch panel). ARDUINO® Uno V3 connectors provide easy connection to extension shields or daughterboards for specific applications.

STLINK-V3E is integrated into the board, as an embedded in-circuit debugger and programmer for the STM32 microcontroller and the USB Virtual COM port bridge.

The STM32H745I-DISCO and STM32H750B-DK boards come with the STM32CubeH7 MCU package, which provides an STM32 comprehensive software HAL library as well as various software examples.

Figure 1. STM32H745I-DISCO and STM32H750B-DK boards (top view)



Figure 2. STM32H745I-DISCO and STM32H750B-DK boards (bottom view)

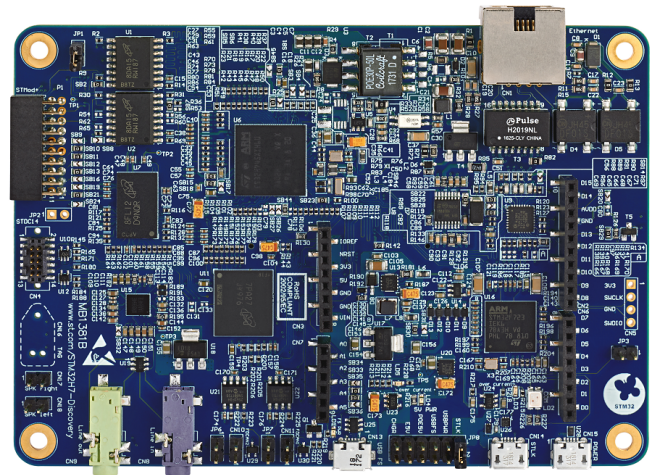

Pictures are not contractual. PCB colors may differ.

1 Features

- Arm® Cortex® core-based microcontroller with 2 Mbytes (STM32H745XIH6) or 128 Kbytes (STM32H750XBH6) of Flash memory and 1 Mbyte of RAM, in TFBGA240+25 package
- 4.3" RGB interface LCD with touch panel connector
- Ethernet compliant with IEEE-802.3-2002, and PoE
- USB OTG FS with Micro-AB connector
- SAI audio codec
- One ST-MEMS digital microphone
- 2× 512-Mbit Quad-SPI NOR Flash memory
- 128-Mbit SDRAM
- 4-Gbyte on-board eMMC
- 1 user and reset push-button
- Fanout daughterboard
- 2× CAN FDs
- Board connectors:
 - USB FS Micro-AB connectors
 - ST-LINK Micro-B USB connector
 - USB power Micro-B connector
 - Ethernet RJ45
 - Stereo headset jack including analog microphone input
 - Audio header for external speakers
 - Tag-Connect (TAG) 10-pin footprint
 - Arm® Cortex® 10-pin 1.27 mm pitch debug connector over STDC14 footprint
 - ARDUINO® Uno V3 expansion connectors
 - STMod+
- Flexible power-supply options:
 - STLINK-V3 USB connector, USB FS connector
 - 5 V delivered by RJ45 (Power over Ethernet)
 - 5 V delivered by ARDUINO® or external connector
 - USB charger
 - USB power
- On-board STLINK-V3E debugger/programmer with USB re-enumeration capability: mass storage, Virtual COM port, and debug port
- Support of a wide choice of Integrated Development Environments (IDEs) including IAR Embedded Workbench®, MDK-ARM, and STM32CubeIDE

Note: Arm is a registered trademark of Arm Limited (or its subsidiaries) in the US and/or elsewhere.

2 Ordering information

To order the [STM32H745I-DISCO](#) and [STM32H750B-DK](#) Discovery kits, refer to [Table 1](#). Additional information is available from the datasheet and reference manual of the target STM32.

Table 1. List of available products

Order code	Board reference	Target STM32
STM32H745I-DISCO	MB1381	STM32H745XIH6
STM32H750B-DK		STM32H750XBH6

2.1 Codification

The codification composition is detailed in [Table 2](#).

Table 2. Codification explanation

STM32H7XXY-DISCO STM32H7XXY-DK	Description	Example: STM32H745I-DISCO
STM32H7	MCU series in STM32 32-bit Arm Cortex MCUs	STM32H7 Series
XX	MCU product line in the series	STM32H745
Y	STM32 Flash memory size: <ul style="list-style-type: none"> • B for 128 Kbytes • I for 2 Mbytes 	2 Mbytes
DISCO / DK	Discovery kit	Discovery kit

3 Development environment

3.1 System requirements

- Multi-OS support: Windows® 10, Linux® 64-bit, or macOS®
- USB Type-A or USB Type-C® to Micro-B cable

Note: macOS® is a trademark of Apple Inc. registered in the U.S. and other countries.
Linux® is a registered trademark of Linus Torvalds.
All other trademarks are the property of their respective owners.

3.2 Development toolchains

- IAR Systems® - IAR Embedded Workbench®⁽¹⁾
- Keil® - MDK-ARM⁽¹⁾
- STMicroelectronics - STM32CubeIDE

1. On Windows® only.

3.3 Demonstration software

The demonstration software, included in the STM32Cube MCU Package corresponding to the on-board microcontroller, is preloaded in the STM32 Flash memory for easy demonstration of the device peripherals in standalone mode. The latest versions of the demonstration source code and associated documentation can be downloaded from www.st.com.

4 Conventions

Table 3 provides the conventions used for the ON and OFF settings in the present document.

Table 3. ON/OFF convention

Convention	Definition
Jumper JPx ON	Jumper fitted
Jumper JPx OFF	Jumper not fitted
Jumper JPx [1-2]	Jumper fitted between Pin 1 and Pin 2
Solder bridge SBx ON	SBx connections closed by 0 Ω resistor
Solder bridge SBx OFF	SBx connections left open
Resistor Rx ON	Resistor soldered
Resistor Rx OFF	Resistor not soldered

5 Delivery recommendations

Before first use, check the board for any damage that might have occurred during shipment, that all socketed components are firmly fixed in their sockets and that none are loose in the plastic bag.

6 Hardware layout and configuration

The **STM32H745I-DISCO** and **STM32H750B-DK** Discovery kits are designed around the **STM32H745XIH6** and **STM32H750XBH6** microcontrollers, respectively. Both microcontrollers are packaged in **TFBGA240+25**. The hardware block diagram (see **Figure 3**) illustrates the connection between the microcontroller and the peripherals (SDRAM, eMMC, Quad-SPI Flash memory, CAN FD (FDCAN), LCD RGB connector, USB OTG connectors, UART, Ethernet, Audio, TAG connector, STDC connector, ARDUINO® Uno shields and embedded ST-LINK).

Figure 4 and **Figure 5** help to locate these features on the **STM32H745I-DISCO** and **STM32H750B-DK** boards.

Figure 3. Hardware block diagram

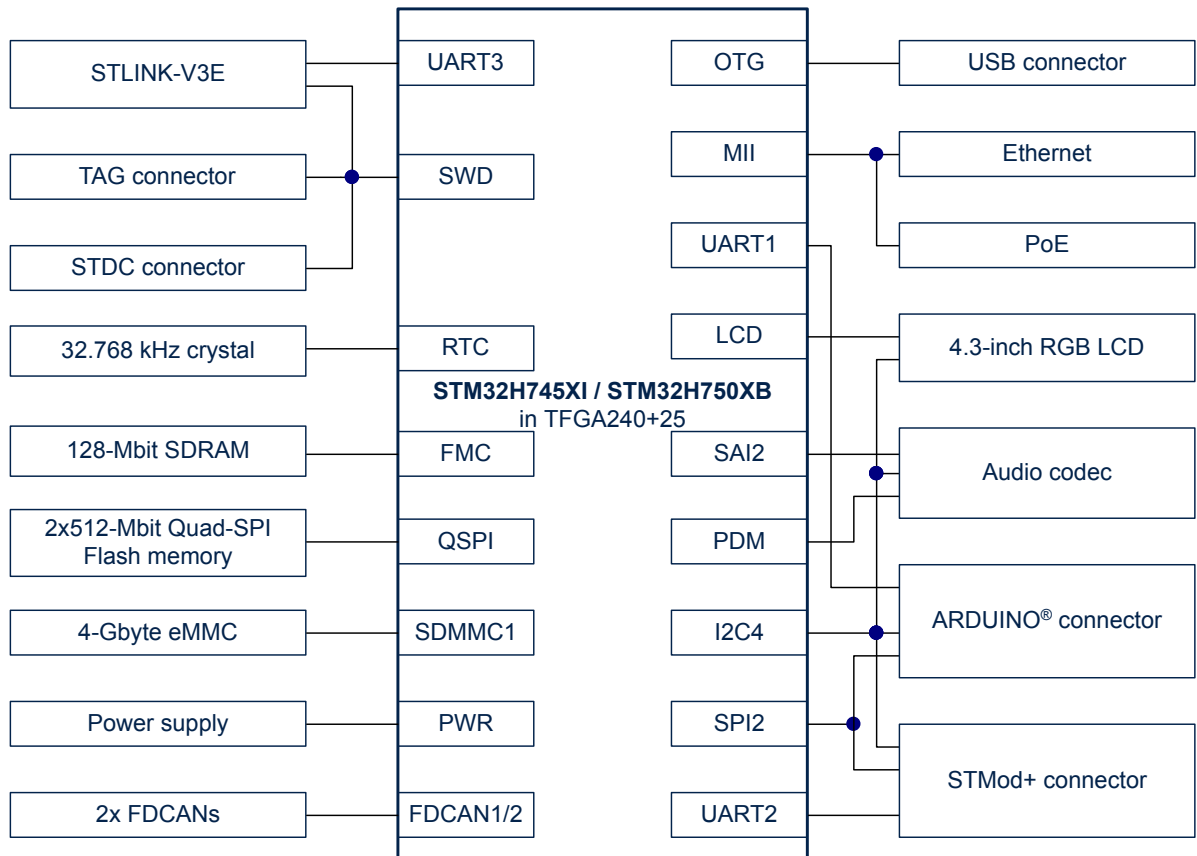

6.1 STM32H745I-DISCO and STM32H750B-DK layout

Figure 4. STM32H745I-DISCO and STM32H750B-DK Discovery board top layout

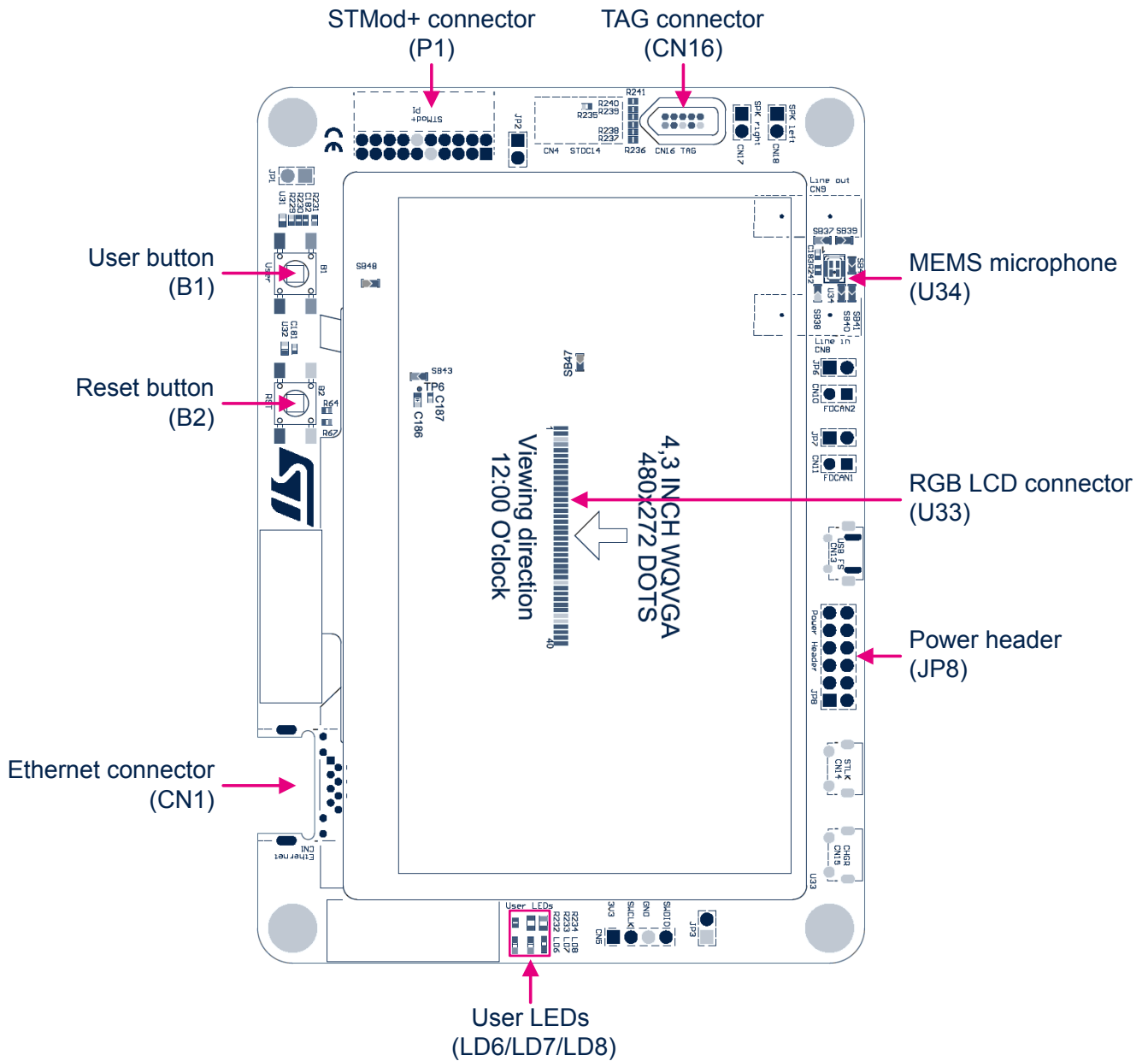
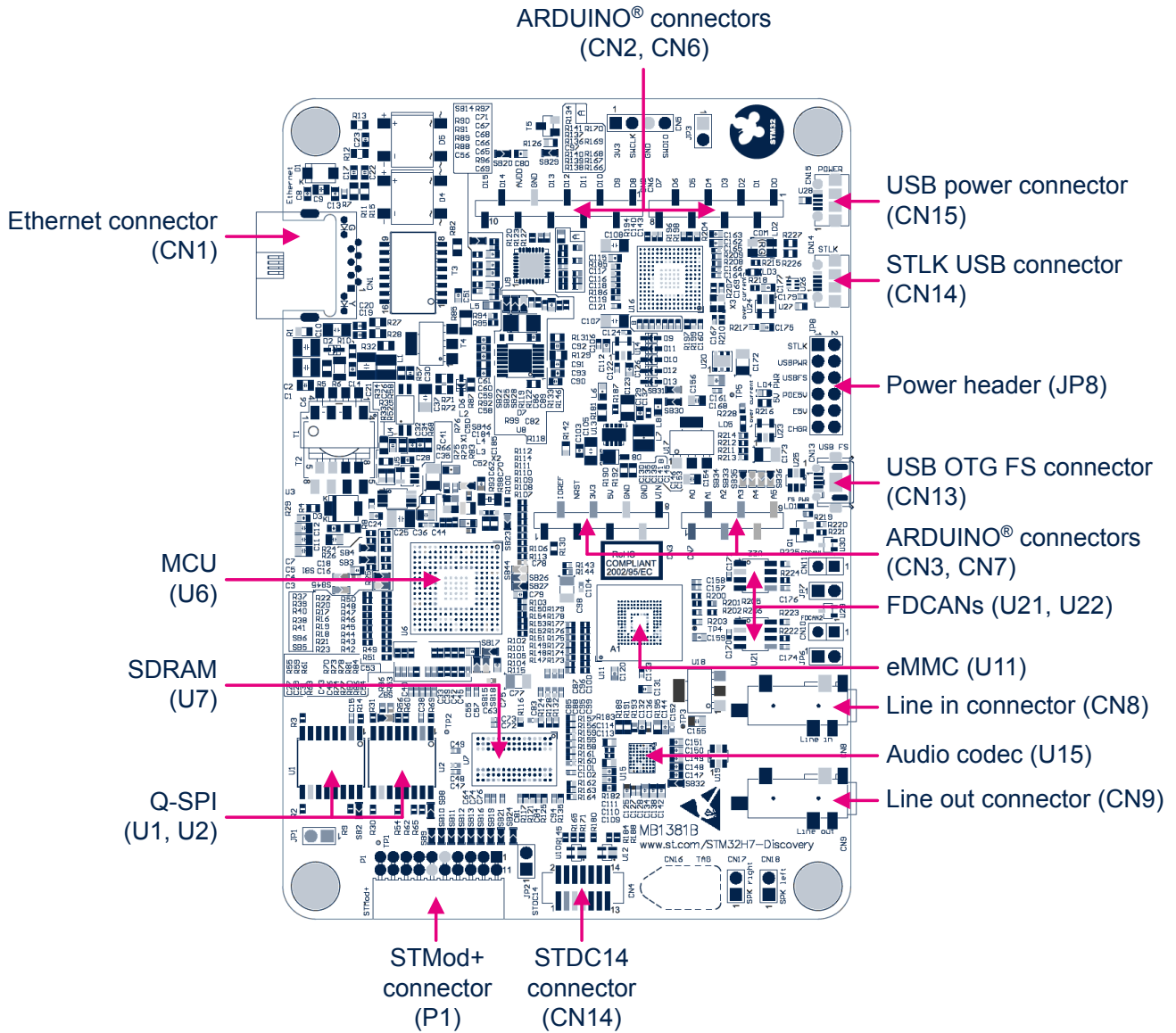

Figure 5. STM32H745I-DISCO and STM32H750B-DK Discovery board bottom layout



6.2 STM32H745I-DISCO and STM32H750B-DK mechanical drawing

Figure 6 shows the mechanical dimensions of the STM32H745I-DISCO and STM32H750B-DK boards.

Figure 6. STM32H745I-DISCO and STM32H750B-DK Discovery board mechanical drawing (bottom view)

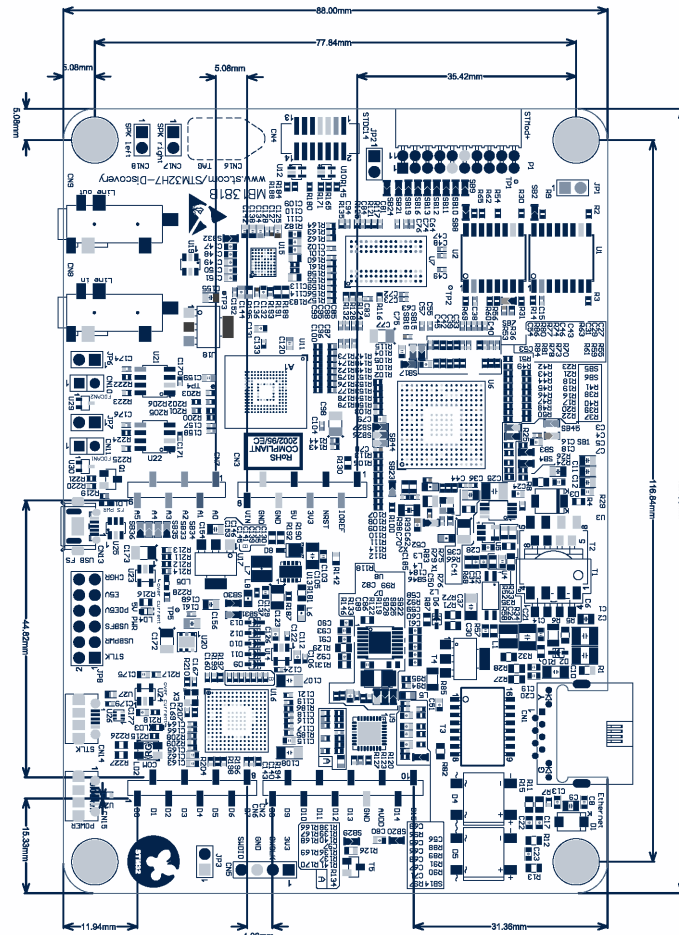

6.3 Embedded STLINK-V3E

The STLINK-V3E programming and debugging tool is integrated into the STM32H745I-DISCO and STM32H750B-DK Discovery kits. It supports:

- USB software re-enumeration
- Virtual COM port interface on USB
- Mass storage interface on USB
- USB power management request for more than 100 mA power on USB

The USB connector (CN14) can be used to power the STM32H745I-DISCO and STM32H750B-DK regardless of the STLINK-V3E facility used for debugging or programming the STM32H745XIH6 and STM32H750XBH6. This holds also when the STLINK-V3E standalone tool is connected to CN4 or CN16 connector and used for debugging or programming the STM32H745XIH6 and STM32H750XBH6. Section 6.4 Power supply provides more details about STM32H745I-DISCO and STM32H750B-DK powering.

Refer to www.st.com for details about STLINK-V3E.

Drivers and firmware upgrade

The STLINK-V3E requires drivers to be installed on Windows®. It embeds a firmware that needs to be updated from time to time in order to benefit from new functionalities and bug corrections. Refer to technical note *Overview of ST-LINK derivatives* (TN1235) for details.

6.4 Power supply

The [STM32H745I-DISCO](#) and [STM32H750B-DK](#) Discovery kits are designed to be powered from a 5 V DC power source. Either of the following five 5 V DC power inputs can be used, upon appropriate board configuration:

- Micro-B USB receptacle CN14 of STLINK-V3E without enumeration: up to 500 mA can be supplied to the board (JP8 jumper setting on CHGR position on the silkscreen).
- 7 to 12 V DC power from CN3 pin 8: named VIN on the silkscreen, extension connectors for ARDUINO® Uno shields or daughterboard (JP8 jumper setting on E5V on the silkscreen).
- 48 V DC power from RJ45 connector CN1 (Ethernet):
 In this case, the on-board module PoE (Power over Ethernet) generates the 5 V supply voltage with up to 600 mA. This module is a powered device complying with IEEE 802.3af, class 1 / 2 standard. The external power supply must be fully IEEE 802.3af compliant (JP8 jumper setting on POE5V on the silkscreen).
- Micro-AB USB receptacle CN13 of the USB OTG_FS interface: marked USB OTG FS on the board (JP8 jumper setting on USBFS on the silkscreen), and supplying up to 500 mA to the board.
- Micro-B USB receptacle CN15 of the USB power: marked USB PWR on the board (JP8 jumper setting on USBPWR on the silkscreen), and supplying up to 500 mA to the board.
- Micro-B USB receptacle CN14 of STLINK-V3E with enumeration: with enumeration feature (see [Supplying the board through the STLINK-V3E USB port](#)), up to 500 mA can be supplied to the board (JP8 jumper setting on STLK on the silkscreen).

The LD4 green LED turns ON when the voltage on the power line marked as +5 V is present. All the supply voltage lines required for the operation of the [STM32H745I-DISCO/STM32H750B-DK](#) components are derived from this +5 V line.

Supplying the board through the STLINK-V3E USB port

To power the [STM32H745I-DISCO](#) and [STM32H750B-DK](#) in this way, the USB host (a PC) gets connected to the Micro-B USB receptacle of the board via a USB cable. The connection event starts the USB enumeration procedure. In its initial phase, the host USB port current supply capability is limited to 100 mA. This is sufficient since only the STLINK-V3E part of the [STM32H745I-DISCO/STM32H750B-DK](#) draws power at that time: the U24 STMPS2151 power switch is set to the OFF position, which isolates the rest of the board from the power source. In the next phase of the enumeration procedure, the host PC informs the STLINK-V3E that it is able to supply current up to 300 mA. If the answer is positive, the STLINK-V3E sets the U24 STMPS2151 switch to the ON position to supply power to the rest of the board. Otherwise, CN3 pin 8 (VIN) or CN15 can be used to supply the board instead.

Should a short-circuit occur on the board, the STMPS2151 power switch protects the USB port of the host PC against a current demand exceeding 500 mA. In such an event, the LD4 LED lights up.

The [STM32H745I-DISCO](#) and [STM32H750B-DK](#) boards can also be supplied from a USB power source that does not support enumeration, such as a USB charger. In this particular case, JP6 jumper must be ON with a jumper hat as shown in [Table 4. Power-supply related jumper and solder bridge settings](#). STLINK-V3E bypasses STMPS2151 power regardless of the enumeration procedure result and passes the power unconditionally to the board.

The LD4 green LED turns ON whenever the whole board is powered.

Using STLINK-V3E along with powering through external power

It can happen that the board requires a supply current higher than 300 mA. It consequently cannot be supplied from host PC connected to STLINK-V3E USB port for debugging or programming the [STM32H745XIH6](#) or [STM32H750XBH6](#) microcontroller. In such a case, the board can be supplied through CN3 pin 8 (marked VIN on the board) or by CN15.

To do this, it is important to power the board before connecting it with the host PC, which requires the following sequence to be respected:

1. Set jumper JP8 in the E5V or CHGR position.
2. Connect the external power source to CN3 pin 8 or CN15.
3. Check that the green LED LD4 is turned ON.
4. Connect the host PC to USB connector CN14.

Caution: If the board requests more than 300 mA and the host PC is connected via USB before the board is powered from CN3 pin 8 or CN15, the following events may occur (listed in reverse severity order):

1. The host PC is capable of supplying 300 mA (the enumeration succeeds) but does not feature any over-current protection on its USB port. It is damaged due to over-current.
2. The host PC is capable of supplying 300 mA (the enumeration succeeds) and it has a built-in over-current protection on its USB port, limiting or shutting down the power out of its USB port when the excessive current demand from [STM32H745I-DISCO/STM32H750B-DK](#) is detected. This causes an operating failure of the board.
3. The host PC is not capable of supplying 300 mA (the enumeration fails). The STLINK-V3E does not supply the rest of the [STM32H745I-DISCO/STM32H750B-DK](#) from its USB port VBUS line.

SMPS/LDO power supply

There are three solutions to provide power to the microcontroller V_{CORE} logic supply: SMPS, LDO, and SMPS and LDO. Power consumption in Run mode is significantly improved by generating V_{CORE} from the internal DC/DC converter (SMPS) and the default connection must be set to SMPS. Some modifications are required to supply the microcontroller from the LDO. Below the board configuration for each case:

- LDO mode (default on the [STM32H750XB](#)): mount SB6, SB17 and SB45; remove SB5, SB18, SB26, SB27, SB44, SB46 and L4.
- SMPS mode (default on the [STM32H745XI](#)): mount SB5, SB18, SB44, SB46 and L4; remove SB6, SB17, SB27, SB26 and SB45.
- SMPS plus LDO mode: mount SB6, SB17, SB44, SB46 and L4; remove SB26, SB5, SB18, SB27 and SB45.

Caution: A deadlock occurs if the [STM32H745I-DISCO](#) SMPS/LDO firmware PWR configuration does not match the board hardware configuration: after the reset, the ST-LINK cannot connect the target anymore.

The firmware PWR configuration must be set as follows in function `SystemClock_Config` in file `main.c`:

- If the hardware configuration is *Direct SMPS* (default configuration):

```
HAL_PWREx_ConfigSupply(PWR_DIRECT_SMPS_SUPPLY);
```
- If the hardware configuration is *LDO*:

```
HAL_PWREx_ConfigSupply(PWR_LDO_SUPPLY);
```

If a deadlock occurs because of a mismatch between hardware and firmware PWR settings (SMPS/LDO), the user can recover the [STM32H745I-DISCO](#) board by applying the following procedure:

1. Power off the board.
2. Remove the 10 kΩ resistor from R143 and mount it on R144.
 This changes the BOOT0 pin to 1 instead of 0, thus changing the device boot address to boot address 1 and making the bootloader start in System memory. This avoids starting firmware in the user Flash with a wrong SMPS/LDO configuration versus the hardware board configuration.
3. Power on the board and connect using STM32CubeProgrammer ([STM32CubeProg](#)).
4. Erase the user Flash.
5. Power off the board and remove the 10 kΩ resistor from R144 and mount it back on R143.
6. The board is recovered and can be used normally with matching firmware PWR.

Table 4. Power-supply related jumper and solder bridge settings describes the settings of all the jumpers related to the powering of the STM32H745I-DISCO/STM32H750B-DK and the extension board. VDD_MCU corresponds to the STM32H745XIH6/STM32H750XBH6 digital supply voltage line. It can be connected to a fixed 3.3 V supply.

Table 4. Power-supply related jumper and solder bridge settings

Jumper/Solder bridge	Setting	Configuration
JP8 Power source selector		The STM32H745I-DISCO/STM32H750B-DK is supplied through the CN14 Micro-B USB receptacle.
		The STM32H745I-DISCO/STM32H750B-DK is supplied through the pin 8 of CN3 (marked VIN).
		The STM32H745I-DISCO/STM32H750B-DK is supplied through the RJ45 connector CN1.
		The STM32H745I-DISCO/STM32H750B-DK is supplied through the CN13 Micro-AB USB receptacle.
		Default setting The STM32H745I-DISCO/STM32H750B-DK is supplied through the CN14 Micro-B USB receptacle. It depends on host PC USB port powering capability declared in the enumeration.
SB23 VBAT connection	SB23 ON	Default setting VBAT is connected to +3V3.
	SB23 OFF	VBAT is not connected to +3V3.
SB15 VDD_USB connection	SB15 ON	Default setting. VDD_USB (VDDUSB terminal of STM32H745XIH6/STM32H750XBH6) is connected to VDD_MCU.
	SB15 OFF	VDD_USB is not connected to VDD_MCU.
JP1 VDD_MCU connection		Default setting VDD_MCU (VDD terminals of STM32H745XIH6/STM32H750XBH6) is connected to fixed +3.3 V.
		VDD_MCU (VDD terminals of STM32H745XIH6/STM32H750XBH6) is not connected to fixed +3.3 V

Note: STM32H750B-DK only supports the LDO mode.

6.5 Clock sources

Three clock sources are available on the STM32H745I-DISCO and STM32H750B-DK boards:

- X1: 25 MHz oscillator for STM32H745XIH6/STM32H750XBH6 microcontroller and Ethernet PHY.
- X2: 32.768 kHz crystal for STM32H745XIH6/STM32H750XBH6 embedded RTC
- X3: 25 MHz oscillator for STLK.

6.6 Reset sources

The reset signal of the [STM32H745I-DISCO](#) and [STM32H750B-DK](#) Discovery kits is active low. The reset sources include:

- B2 reset button
- ARDUINO® Uno shield board from CN3
- Embedded STLINK-V3E
- TAG connector
- STDC14 receiver
- eMMC
- Ethernet

6.7 Audio

An audio Codec WM8994ECS/R from CIRRUS with four DACs and two ADCs is connected to the [STM32H745XIH6](#) and [STM32H750XBH6](#) SAI interface. It communicates with the [STM32H745XIH6](#) and [STM32H750XBH6](#) microcontrollers via an I²C bus shared with the touchpanel of the RGB LCD, ARDUINO® and STMod+ connectors.

- The analog input line is connected to the WM8994ECS/R ADC through the blue audio jack (CN8).
- The analog output line is connected to the WM8994ECS/R DAC via the green audio jack (CN9).
- Two external speakers can be connected to WM8994ECS/R via CN18 for left speaker and CN17 for right speaker.
- The [STM32H745I-DISCO](#) and [STM32H750B-DK](#) feature one digital MP34DT01TR microphones (ST MEMs microphone). They are connected to the input digital microphones of the [STM32H745XIH6](#)/[STM32H750XBH6](#) and are managed by the PDM functionality.

6.8 USB OTG_FS

The [STM32H745I-DISCO](#) and [STM32H750B-DK](#) boards support USB OTG full-speed communications via the CN13 USB Micro-AB connector.

The USB connectors can power the Discovery kit with a 5 V DC supply voltage, at a current up to 500 mA.

A USB power switch is also connected to VBUS and provides power to CN13. The green LED LD1 is lit when either one of the following event occurs:

- The power switch is ON and the [STM32H745I-DISCO](#)/[STM32H750B-DK](#) operate as a USB host.
- VBUS is powered by another USB host when the [STM32H745I-DISCO](#)/[STM32H750B-DK](#) operate as a USB device.

The red LED LD5 is lit when an overcurrent occurs.

Note: The [STM32H745I-DISCO](#) and [STM32H750B-DK](#) boards must be powered by external power supply when using the OTG function.

6.9 eMMC

The [STM32H745I-DISCO](#) and [STM32H750B-DK](#) embed a 4-Gbyte eMMC chip. It is connected to the [STM32H745XIH6](#) and [STM32H750XBH6](#) SDMMC1 port.

6.10 Ethernet

The [STM32H745I-DISCO](#) and [STM32H750B-DK](#) boards support 10M/100M Ethernet communications by a MICROCHIP LAN8740Ai-EN-TR PHY, which supports IEEE 802.3az Energy Efficient Ethernet (EEE) and integrated RJ45 connector CN1. The Ethernet PHY is connected to the [STM32H745XIH6](#)/[STM32H750XBH6](#) microcontroller through an MII interface.

The PHY 25 MHz clock is generated from the X1 oscillator, while the [STM32H745XIH6](#)/[STM32H750XBH6](#) 50 MHz clock is generated by the PHY MII_REF_CLK.

Half-duplex operation

With the default settings, Ethernet half-duplex operation is not working because of a multiplex of I/Os between Ethernet MII_CRS and MII_COL, and Q-SPI Flash memory QSPI_BK2_IO0 and QSPI_BK2_IO1. Table 5 shows the possible settings of all solder bridges or resistors associated with Ethernet on the boards.

Table 5. Ethernet-related solder bridge and resistor settings

Solder bridges / Resistors	Setting	Configuration
SB3, SB4, R38, R40	SB3 and SB4 OFF R38 and R40 ON	Default setting. PH2 and PH3 are connected to the Q-SPI Flash memory. Ethernet half-duplex operation is not supported.
	SB3 and SB4 ON R38 and R40 OFF	PH2 and PH3 are connected to the Ethernet PHY. Ethernet half-duplex operation is supported.

6.11 Power over Ethernet

The *STM32H745I-DISCO* and *STM32H750B-DK* Discovery boards embed a power module that uses Ethernet. This module is an IEEE802.3af compliant class 1 / 2 PoE converter, based on a simple diode rectified Flyback topology built around ST PM8800A component. This “powered device” module accepts a 48 V input voltage and can deliver 5 V with 600 mA.

6.12 SDRAM

A 128-Mbit SDRAM (MT48LC4M32B2B5-6A IT_L TR from MICRON) is connected to the STM32H745XIH6/STM32H750XBH6 FMC interface.

6.13 Quad-SPI NOR Flash memory

By default, two 512-Mbit Quad-SPI NOR Flash memories (MT25QL512ABB8ESF-0SIT from MICRON) are connected to the STM32H745XIH6/STM32H750XBH6 Quad-SPI interface. A single 1-Gbit Quad-SPI NOR Flash memory (MT25TL01GHBB8ESF-0SIT from MICRON) can also be plugged on the board. In this case, configure the board as follows:

- U1/U2/R14/R3/R2/R9/SB2/C15 ON
- R53/R62/R54/R56/R60/SB8/SB48 OFF

6.14 Virtual COM port

The USART3 serial interface is directly available as a virtual COM port of the PC, connected to the STLINK-V3 USB connector (CN14). The virtual COM port settings as the following:

- 115200 baud
- 8-bit data
- No parity
- 1 stop bit
- no flow control

6.15 RGB LCD display

The on-board color display is a 4.3 inch 480x272 LCD-TFT with capacitive touchpanel. It is connected to the STM32H745XIH6/STM32H750XBH6 LCD interface.

6.16 Buttons and LEDs

The black button (B2), located on the board top side, is the reset of the STM32H745XIH6 and STM32H750XBH6 microcontrollers. Refer to [Figure 4. STM32H745I-DISCO and STM32H750B-DK Discovery board top layout](#). The blue button (B1), located on the top side, is available to be used as a digital input or as Wakeup alternate function. [Table 6](#) summarizes the assignment of the control ports to the LED indicators.

Table 6. Assignment of control ports to LED

Reference	Color	Name	Comment
B1	Blue	USER	Wakeup alternate function
B2	Black	RESET	-
LD1	Green	VBUS USB FS	PA9
LD2	Green/Red	STLK COM	Green when communication ongoing
LD3	Red	STLK Over Current	-
LD4	Green	PWR	-
LD5	Green	OTG Over Current	PH11
LD6	Red	USER1	PI13
LD7	Green	USER2	PJ2
LD8	Green	ARDUINO	PD3

7 Connectors

7.1 ARDUINO® Uno V3 connectors

CN2, CN3, CN6 and CN7 are female connectors compatible with the ARDUINO® standard. Most shields designed for ARDUINO® can fit to the [STM32H745I-DISCO](#) and [STM32H750B-DK](#) Discovery kits. The [STM32H745I-DISCO/STM32H750B-DK](#) ARDUINO® connectors support ARDUINO® Uno V3.

Caution: The STM32 microcontroller I/Os are 3.3 V compatible instead of 5 V for ARDUINO® Uno.

Table 7. ARDUINO® connectors (CN2, CN3, CN6, and CN7)

Left connectors					Right connectors				
CN number	Pin number	Pin name	Microcontroller pin	Function	Function	Microcontroller pin	Pin name	Pin number	CN number
					I2C1_SCL	PD12	D15	10	CN2 digital
					I2C1_SDA	PD13	D14	9	
					AVDD	-	AREF	8	
					Ground	-	GND	7	
CN3 power	1	NC	-	-	SPI2_SCK	PD3	D13	6	
	2	IOREF	-	3.3 V Ref	SPI2_MISO	PI2	D12	5	
	3	RESET	NRST	RESET	TIM12_CH2, SPI2_MOSI	PB15	D11	4	
	4	3V3	-	3.3 V input/output	TIM3_CH1, SPI2_NSS	PB4	D10	3	
	5	5V	-	5 V output	TIM8_CH3N	PH15	D9	2	
	6	GND	-	Ground	-	PE3	D8	1	
	7	GND	-	Ground	-				
8	VIN	-	Power input	-	PI8	D7	8	CN6 digital	
					TIM15_CH2	PE6	D6		7
CN7 analog	1	A0	PC0	ADC123_IN10	TIM1_CH1	PA8	D5		6
	2	A1	PF8	ADC3_IN7	-	PK1	D4		5
	3 ⁽¹⁾	A2	PA0_C	ADC12_IN0	TIM3_CH1	PA6	D3		4
	4 ⁽¹⁾	A3	PA1_C	ADC12_IN1	-	PG3	D2		3
	5 ⁽¹⁾	A4	PC2_C or PD13	ADC3_IN0 (PC2) or I2C1_SDA (PD13)	USART1_TX	PB6	D1	2	
	6 ⁽¹⁾	A5	PC3_C or PD12	ADC3_IN1 (PC3) or I2C1_SCL (PD12)	USART1_RX	PB7	D0	1	

1. Supports analog input only. The current capability is limited to 1 mA when used as digital output or input.

7.2 CN13 USB OTG_FS Micro-AB connector

Figure 7. CN13 USB OTG Micro-AB connector (front view)

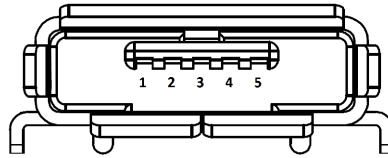

Table 8. CN13 USB OTGFS micro-AB connector

Pin number	Description	Pin number	Description
1	VBUS	4	ID
2	D-	5	GND
3	D+	-	-

7.3 CN1 Ethernet RJ45 connector

Figure 8. CN1 Ethernet RJ45 connector (front view)

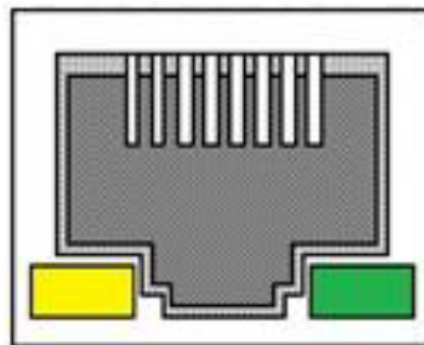

Table 9. CN1 Ethernet RJ45 connector

Pin number	Description	Pin number	Description
1	TX+	7	Nc7
2	TX-	8	Nc8
3	RX+	9	K, yellow LED
4	Nc4	10	A, yellow LED
5	Nc5	11	K, green LED
6	RX-	12	A, green LED

7.4 LCD RGB connector

Figure 9. LCD RGB connector (footprint)

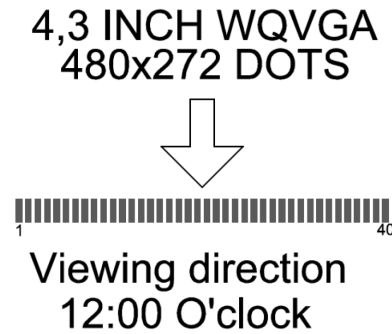

Table 10. LCD RGB connector

	Description	Pin connection	Pin number	Description	Pin connection
1	LCD_BL_K	-	2	LCD_BL_A	-
3	GND	-	4	VDD	-
5	LCD_R0	PI15	6	LCD_R1	PJ0
7	LCD_R2	PJ1	8	LCD_R3	PH9
9	LCD_R4	PJ3	10	LCD_R5	PJ4
11	LCD_R6	PJ5	12	LCD_R7	PJ6
13	LCD_G0	PJ7	14	LCD_G1	PJ8
15	LCD_G2	PJ9	16	LCD_G3	PJ10
17	LCD_G4	PJ11	18	LCD_G5	PI0
19	LCD_G6	PI1	20	LCD_G7	PK2
21	LCD_B0	PJ12	22	LCD_B1	PJ13
23	LCD_B2	PJ14	24	LCD_B3	PJ15
25	LCD_B4	PK3	26	LCD_B5	PK4
27	LCD_B6	PK5	28	LCD_B7	PK6
29	GND	-	30	LCD_CLK	PI14
31	LCD_DISP	PD7	32	LCD_HSYNC	PI12
33	LCD_VSYNC	PI9	34	LCD_DE	PK7
35	GND	-	36	GND	-
37	LCD_RST	-	38	LCD_INT	PG2
39	LCD_SCL	PD12	40	LCD_SDA	PD13

7.5 CN2 STMod+ connector

An STMod+ connector is available on the [STM32H745I-DISCO](#) and [STM32H750B-DK](#) Discovery kits. It provides flexibility in small form factor applications. In addition, the STMod+ connector expands the SPI interface and frees I/Os that can be used by other peripheral expansions.

Table 11. CN2 STMod+ connector

Pin number	Description	Pin number	Description
1	SS/CTS (PA15/PA0)	11	INT (PH12)
2	MOSI/TXD (PB15/PD5)	12	RESET (PH10)
3	MISO/RXD (PI2/PD6)	13	ADC (PA4)
4	SCK/RTS (PD3/PD4)	14	PWM (PA3)
5	GND	15	5V
6	5V	16	GND
7	I2C_SCL (PD12)	17	GPIO (PH1)
8	MOSIs (PI3)	18	GPIO (PI11)
9	MISOs (PB14)	19	GPIO (PH4)
10	I2C_SDA (PD13)	20	GPIO (PH8)

7.6 CN14 STLINK-V3 USB Micro-B connector

The CN14 USB connector is used to connect the embedded STLINK-V3E to the host PC in order to program and debug the STM32H745XIH6/STM32H750XBH6 microcontroller.

Figure 10. CN14 USB Micro-B connector (front view)

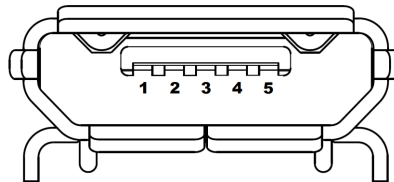

Table 12. CN14 USB Type-B connector

Pin number	Description	Pin number	Description
1	VBUS (power)	4	GND
2	DM	5, 6	Shield
3	DP	-	-

7.7 Audio stereo speaker header connectors (CN17 and CN18)

The stereo audio outputs, CN17 and CN18, can support the left and right stereo speakers, respectively.

7.8 CN9 audio line output (green jack) connector

A 3.5 mm stereo audio green jack output, CN9, can support the headphone.

7.9 CN8 audio line input (blue jack) connector

A 3.5 mm stereo audio green jack input, CN8, can support the audio line input.

7.10 CN16 TAG connector

The CN16 TAG connector is used to connect the STM32H745XIH6/STM32H750XBH6 microcontroller for the board programming and debugging.

Figure 11. CN16 TAG debugging connector (top view)

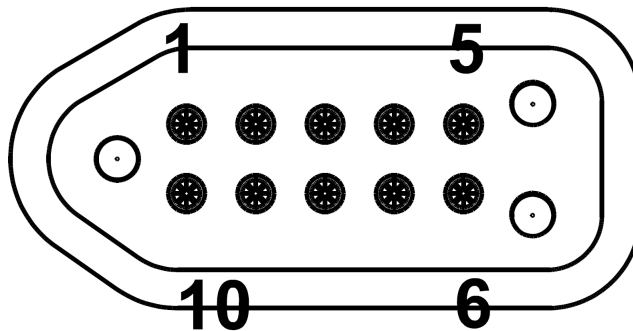

Table 13. CN16 TAG connector

Pin number	Description	Pin number	Description
1	VDD	10	RESET#
2	SWDIO(PA13)	9	NA
3	GND	8	TDI(PA15)
4	SWCLK(PA14)	7	NA
5	GND	6	SWO(PB3)

7.11 CN4 STDC14 connector

The STDC14 connector can be used to program/debug the microcontroller in an external application board using a cable connected to the CN4 SWD connector.

Table 14. STDC14 connector

Pin number	Description	Pin number	Description
1	NC	8	T_SWO
2	NC	9	NC
3	3V3	10	T_JTDI
4	T_SWDIO	11	GNDDETECT
5	GND	12	T_NRST
6	T_SWCLK	13	T_VCP_RX
7	GND	14	T_VCP_TX

7.12 CN15 USB power connector

Figure 12. CN15 USB Micro-B connector (front view)

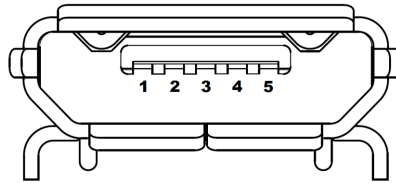

Table 15. CN15 USB Micro-B connector

Pin number	Description	Pin number	Description
1	VBUS	4	NC
2	NC	5	GND
3	NC	-	-

8 STM32H745I-DISCO and STM32H750B-DK I/O assignment

Table 16. STM32H745I-DISCO and STM32H750B-DK I/O assignment

Pin name	Pin number	Signal or label	Comment
PA0	N5	STMOD#1-CTS	-
PA1	N4	MII_RX_CLK	-
PA2	N3	MII_MDIO	-
PA3	U2	STMOD#14-PWM	-
PA4	U3	STMOD#13-ADC	-
PA5	T3	OTG_FS2_PSO	-
PA6	R3	ARD_D3	-
PA7	R5	MII_RX_DV	-
PA8	E5	ARD_D5	-
PA9	D15	VBUS_FS2	-
PA10	D14	USB_OTG_FS2_ID	-
PA11	E17	USB_OTG_FS2_N	-
PA12	E16	USB_OTG_FS2_P	-
PA13	C15	SWDIO	SWDIO
PA14	B14	SWCLK	SWCLK
PA15	A14	STMOD#1_SPI_CS T_JTDI	-
PB0	U5	MII_RXD2	-
PB1	T5	MII_RXD3	-
PB2	R6	MII_TX_ER	-
PB3	C6	SWO	-
PB4	B7	ARD_D10	-
PB5	A5	FDCAN2_RX	-
PB6	B5	ARD_D1	-
PB7	C5	ARD_D0	-
PB8	D5	SDIO1_D4	-
PB9	D4	SDIO1_D5	-
PB10	P11	VCP_TX	-
PB11	P12	VCP_RX	-
PB12	T14	LCD_RST	-
PB13	U14	FDCAN2_TX	-
PB14	U15	STMOD#9-MISOs	-
PB15	T15	ARD_D11	-
PC0	L2	ARD_A0	-
PC1	M2	MII_MDC	-
PC2	M3	MII_TXD2	-
PC3	M4	MII_TX_CLK	-
PC4	T4	MII_RXD0	-

Pin name	Pin number	Signal or label	Comment
PC5	U4	MII_RXD1	-
PC6	F14	SDIO1_D6	-
PC7	F13	SDIO1_D7	-
PC8	E13	SDIO1_D0	-
PC9	E14	SDIO1_D1	-
PC10	A13	SDIO1_D2	-
PC11	B13	SDIO1_D3	-
PC12	C12	SDIO1_CK	-
PC13	E3	WAKEUP	-
PC14	C2	OSC32_IN	-
PC15	C1	OSC32_OUT	-
PD0	D13	SDRAM_D2	-
PD1	E12	SDRAM_D3	-
PD2	D12	SDIO1_CMD	-
PD3	B12	ARD_D13	-
PD4	A12	STMOD#4-RTS	-
PD5	A11	STMOD#2-TX	-
PD6	B11	STMOD#3-RX	-
PD7	C11	LCD_DISP	-
PD8	U16	SDRAM_D13	-
PD9	T17	SDRAM_D14	-
PD10	T16	SDRAM_D15	-
PD11	R15	QSPI_BK1_IO0	-
PD12	R16	IIC4_SCL	-
PD13	R17	IIC4_SDA	-
PD14	P16	SDRAM_D0	-
PD15	P15	SDRAM_D1	-
PE0	C4	SDRAM_NBL0	-
PE1	B4	SDRAM_NBL1	-
PE2	C3	MII_TXD3	-
PE3	D3	ARD_D8	-
PE4	D2	SAI4_D2	-
PE5	D1	SAI4_CK2	-
PE6	E5	ARD_D6	-
PE7	U9	SDRAM_D4	-
PE8	T9	SDRAM_D5	-
PE9	P9	SDRAM_D6	-
PE10	N9	SDRAM_D7	-
PE11	P10	SDRAM_D8	-
PE12	R10	SDRAM_D9	-
PE13	T10	SDRAM_D10	-

Pin name	Pin number	Signal or label	Comment
PE14	U10	SDRAM_D11	-
PE15	R11	SDRAM_D12	-
PF0	G4	SDRAM_A0	-
PF1	G3	SDRAM_A1	-
PF2	G1	SDRAM_A2	-
PF3	H4	SDRAM_A3	-
PF4	J5	SDRAM_A4	-
PF5	J4	SDRAM_A5	-
PF6	K2	QSPI_BK1_IO3	-
PF7	K3	QSPI_BK1_IO2	-
PF8	K4	ARD_A1	-
PF9	L4	QSPI_BK1_IO1	-
PF10	L3	QSPI_CLK	-
PF11	T7	SDRAM_SDNRAS	-
PF12	R7	SDRAM_A6	-
PF13	P7	SDRAM_A7	-
PF14	P8	SDRAM_A8	-
PF15	R9	SDRAM_A9	-
PG0	T8	SDRAM_A10	-
PG1	U8	SDRAM_A11	-
PG2	H16	LCD_INT	-
PG3	H15	ARD_D2	-
PG4	H14	SDRAM_BA0	-
PG5	G14	SDRAM_BA1	-
PG6	G15	RCC_OSC_OUT	-
PG7	F16	Audio_Int	-
PG8	F15	SDRAM_SDCLK	-
PG9	A10	QSPI_BK2_IO2	-
PG10	A9	SAI2_SDB	-
PG11	B9	MII_TX_EN	-
PG12	C9	MII_TXD1	-
PG13	D9	MII_TXD0	-
PG14	D8	QSPI_BK2_IO3	-
PG15	D6	SDRAM_SDNCAS	-
PH0	J2	OSC_25M	-
PH1	J1	STM0D#17	-
PH2	N2	QSPI_BK2_IO0 MII_CRS ⁽¹⁾	-
PH3	P2	QSPI_BK2_IO1 MII_COL ⁽¹⁾	-
PH4	P3	STM0D#19	-
PH5	P4	SDRAM_SDNWE	-
PH6	T11	SDRAM_SDNE1	-

Pin name	Pin number	Signal or label	Comment
PH7	U13	SDRAM_SDCKE1	-
PH8	T13	STMOD#20	-
PH9	R13	LCD_R3	-
PH10	P13	STMOD#12-RST	-
PH11	P14	OTG_FS2_Overcurrent	-
PH12	R14	STMOD#11-INT	-
PH13	D16	FDCAN1_TX	-
PH14	B17	FDCAN1_RX	-
PH15	PF6	ARD_D9	-
PI0	A16	LCD_G5	-
PI1	A15	LCD_G6	-
PI2	B15	ARD_D12	-
PI3	C14	STMOD#8-MOSIs	-
PI4	A4	SAI2_MCLKA	-
PI5	A3	SAI2_SCKA	-
PI6	A2	SAI2_SDA	-
PI7	B3	SAI2_FSA	-
PI8	E4	ARD_D7	-
PI9	E2	LCD_VSYNC	-
PI10	F3	MII_RX_ER	-
PI11	F4	STMOD#18	-
PI12	H1	LCD_HSYNC	-
PI13	H2	LED2	-
PI14	H3	LCD_CLK	-
PI15	P5	LCD_R0	-
PJ0	N6	LCD_R1	-
PJ1	P6	LCD_R2	-
PJ2	T6	LED1	-
PJ3	U6	LCD_R4	-
PJ4	U7	LCD_R5	-
PJ5	R12	LCD_R6	-
PJ6	N15	LCD_R7	-
PJ7	N14	LCD_G0	-
PJ8	N13	LCD_G1	-
PJ9	M14	LCD_G2	-
PJ10	L14	LCD_G3	-
PJ11	K14	LCD_G4	-
PJ12	D11	LCD_B0	-
PJ13	E10	LCD_B1	-
PJ14	D10	LCD_B2	-
PJ15	B10	LCD_B3	-

Pin name	Pin number	Signal or label	Comment
PK0	J14	LCD_BL	-
PK1	J15	ARD_D4	-
PK2	H17	LCD_G7	-
PK3	C8	LCD_B4	-
PK4	B8	LCD_B5	-
PK5	A8	LCD_B6	-
PK6	C7	LCD_B7	-
PK7	D7	LCD_DE	-
-	L16	DSI_CK_P	NC
-	L17	DSI_CK_N	NC
-	M16	DSI_D0_P	NC
-	M17	DSI_D0_N	NC
-	K16	DSI_D1_P	NC
-	K17	DSI_D1_N	NC
-	T1	ARD_A2	-
-	T2	ARD_A3	-
-	R1	ARD_A4	-
-	R2	ARD_A5	-
-	E9	VDD	ARD_D7
-	E11	VDD	-
-	F5	VDD	-
-	G5	VDD	-
-	G13	VDD	-
-	H5	VDD	EXT_RST
-	H13	VDD	-
-	J13	VDD	-
-	K13	VDD	-
-	L13	VDD	-
-	M13	VDD	ARD_A0
-	N12	VDD	-
-	N11	VDD	-
-	N10	VDD	-
-	N7	VDD	DSIHOST_TE
-	L5	VDD	-
-	K5	VDD	-
-	E6	VDD	-
P11	F1	VDDIO_SD1	-
P12	E1	VLX	-
P13	F2	VSSIO_SD	-
P14	U11	VCAP1	-
P15	D17	VCAP2	-

Pin name	Pin number	Signal or label	Comment
R1	A7	VCAP3	-
R2	N8	VDDIO1	-
R3	M5	VDDIO2	-
R4	U12	VDDIO33_LDO1	-
R5	C17	VDDIO33_LDO2	-
R6	A6	VDDIO33_LDO3	-
R7	G17	VDD50_USB	-
R8	F17	VDD_USB33	-
-	L1	VDDA	-
-	M1	VREF+	-
-	B1	VBAT	-
-	A1	VSS	-
-	C10	VSS	-
-	C13	VSS	-
-	C16	VSS	-
-	G16	VSS	-
-	J3	VSS	-
-	N16	VSS	-
-	U17	VSS	-
-	T12	VSS	-
-	R8	VSS	-
-	L9	VSS	-
-	L11	VSS	-
-	K10	VSS	-
-	K11	VSS	-
-	A17	VSS	-
-	L10	VSS	-
-	B6	VSS	-
-	B2	VSS	-
-	R2	VSS	-
-	G7	VSS	-
-	G8	VSS	-
-	G9	VSS	-
-	G10	VSS	-
-	G11	VSS	-
-	H7	VSS	-
-	H8	VSS	-
-	H9	VSS	-
-	H10	VSS	-
-	H11	VSS	-
-	J7	VSS	-

Pin name	Pin number	Signal or label	Comment
-	J8	VSS	-
-	J9	VSS	-
-	J10	VSS	-
-	J11	VSS	-
-	K7	VSS	-
-	K8	VSS	-
-	K9	VSS	-
-	L7	VSS	-
-	L8	VSS	-
-	U1	VSS	-
-	P1	VSSA	-
-	N1	VREF-	-
-	P17	VDD33_DSI	-
-	N17	VDD12_DSI_CAP	-
-	J16	VSSDSI1	-
-	J17	VSSDSI2	-
-	K15	VSSDSI3	-
-	L15	VSSDSI4	-
-	M15	VSSDSI5	-

1. For 10 Mbps half-duplex MII communication, SB3 and SB4 must be ON.

9 STM32H745I-DISCO and STM32H750B-DK product information

9.1 Product marking

The stickers located on the top or bottom side of the PCB provide product information:

- Product order code and product identification for the first sticker
- Board reference with revision, and serial number for the second sticker

On the first sticker, the first line provides the product order code, and the second line the product identification.

On the second sticker, the first line has the following format: "MBxxxx-Variant-yzz", where "MBxxxx" is the board reference, "Variant" (optional) identifies the mounting variant when several exist, "y" is the PCB revision and "zz" is the assembly revision, for example B01. The second line shows the board serial number used for traceability.

Evaluation tools marked as "ES" or "E" are not yet qualified and therefore not ready to be used as reference design or in production. Any consequences deriving from such usage will not be at ST charge. In no event, ST will be liable for any customer usage of these engineering sample tools as reference designs or in production.

"E" or "ES" marking examples of location:

- On the targeted STM32 that is soldered on the board (For an illustration of STM32 marking, refer to the STM32 datasheet "Package information" paragraph at the www.st.com website).
- Next to the evaluation tool ordering part number that is stuck or silk-screen printed on the board.

Some boards feature a specific STM32 device version, which allows the operation of any bundled commercial stack/library available. This STM32 device shows a "U" marking option at the end of the standard part number and is not available for sales.

In order to use the same commercial stack in his application, a developer may need to purchase a part number specific to this stack/library. The price of those part numbers includes the stack/library royalties.

9.2 STM32H745I-DISCO product history

9.2.1 Product identification DKH745IO\$AT1

This product identification is based on the mother board MB1381-H745XI-B01.

It embeds the [STM32H745XIH6](#) microcontroller with silicon revision code "V". The limitations of this silicon revision are detailed in errata sheet *STM32H745/747xI/G and STM32H755/757xI device limitations (ES0445)*.

Product limitations

No limitation identified for this product identification.

9.3 STM32H750B-DK product history

9.3.1 Product identification DK32H750B\$AT1

This product identification is based on the mother board MB1381-H750XB-B01.

It embeds the [STM32H750XBH6](#) microcontroller with silicon revision code "V". The limitations of this silicon revision are detailed in errata sheet *STM32H750xB and STM32H753xI device limitations (ES0396)*.

Product limitations

No limitation identified for this product identification.

9.4 Board revision history

9.4.1 Board MB1381 revision B-01

The revision B-01 is the initial release of master board MB1381.

Product limitations

No limitation identified for this board revision.

Appendix A Federal Communications Commission (FCC) and Industry Canada (IC) Compliance Statements

A.1 FCC Compliance Statement

Part 15.19

This device complies with Part 15 of the FCC Rules. Operation is subject to the following two conditions: (1) this device may not cause harmful interference, and (2) this device must accept any interference received, including interference that may cause undesired operation.

Part 15.21

Any changes or modifications to this equipment not expressly approved by STMicroelectronics may cause harmful interference and void the user's authority to operate this equipment.

Part 15.105

This equipment has been tested and found to comply with the limits for a Class A digital device, pursuant to part 15 of the FCC Rules. These limits are designed to provide reasonable protection against harmful interference when the equipment is operated in a commercial environment. This equipment generates, uses, and can radiate radio frequency energy and, if not installed and used in accordance with the instruction manual, may cause harmful interference to radio communications. Operation of this equipment in a residential area is likely to cause harmful interference in which case the user will be required to correct the interference at his own expense.

Responsible party (in the USA)

Terry Blanchard
Americas Region Legal | Group Vice President and Regional Legal Counsel, The Americas
STMicroelectronics, Inc.
750 Canyon Drive | Suite 300 | Coppel, Texas 75019
USA
Telephone: +1 972-466-7845

A.2 IC Compliance Statement

Industry Canada ICES-003 Compliance Label: *CAN ICES-3 (A) / NMB-3 (A)*.

Appendix B CE conformity

B.1 Warning

EN 55032 / CISPR32 (2012) Class A product

Warning: this device is compliant with Class A of EN55032 / CISPR32. In a residential environment, this equipment may cause radio interference.

Avertissement : cet équipement est conforme à la Classe A de la EN55032 / CISPR 32. Dans un environnement résidentiel, cet équipement peut créer des interférences radio.

Revision history

Table 17. Document revision history

Date	Revision	Changes
8-Jan-2019	1	Initial release.
1-Apr-2019	2	Updated <i>Figure 1</i> and <i>Figure 2</i> on the cover page and reorganized the beginning of the document: <ul style="list-style-type: none"> • Updated <i>Features</i> • Updated <i>Ordering information</i> • Updated <i>Product marking</i> • Added <i>Codification</i> • Added <i>Development environment</i>
6-May-2019	3	Updated the description of the <i>SMPS/LDO power supply</i> default modes in <i>Section 6.4 Power Supply</i> .
12-Sep-2019	4	Updated the descriptions of pins ARD_D0 and ARD_D1 of ARDUINO® connector CN6 in <i>Figure 29. ARDUINO® connectors</i> and correspondingly in <i>Table 6. ARDUINO® connectors (CN2, CN3, CN6, and CN7)</i> . Updated all schematics related to STM32H745I-DISCO in <i>Section 9 Electrical schematics</i> .
31-Jan-2020	5	Updated <i>SMPS/LDO power supply</i> in <i>Section 6.4 Power supply</i> for hardware/firmware mismatch deadlock recovery.
21-Apr-2020	6	Updated for Ethernet half-duplex support: <ul style="list-style-type: none"> • Updated <i>Section 6.10 Ethernet</i> • Updated PH2 and PH3 in <i>Table 16. STM32H745I-DISCO and STM32H750B-DK I/O assignment</i> Updated the document structure: <ul style="list-style-type: none"> • Updated <i>Federal Communications Commission (FCC) and Industry Canada (IC) Compliance Statements</i> • Added <i>CE conformity</i> • Removed <i>Electrical schematics</i>
27-Apr-2021	7	Updated LEDs LD6 and LD7 in <i>Table 6. Assignment of control ports to LED</i> . Added <i>Section 9 STM32H745I-DISCO and STM32H750B-DK product information</i> and included <i>Product marking</i> within.
9-Sep-2021	8	Updated <i>Figure 4</i> and <i>Figure 5</i> . Added limitation to pins A[2...5] of ARDUINO® connector CN7 in <i>Table 7. ARDUINO® connectors (CN2, CN3, CN6, and CN7)</i> .

Contents

1	Features	2
2	Ordering information	3
2.1	Codification	3
3	Development environment	4
3.1	System requirements	4
3.2	Development toolchains	4
3.3	Demonstration software	4
4	Conventions	5
5	Delivery recommendations	6
6	Hardware layout and configuration	7
6.1	STM32H753I-EVAL Evaluation board layout	8
6.2	STM32H753I-EVAL Evaluation board mechanical drawing	10
6.3	Embedded ST_LINK/V2-1	10
6.4	Power supply	11
6.5	Clock sources	13
6.6	Reset sources	14
6.7	Audio	14
6.8	USB OTG_FS	14
6.9	eMMC	14
6.10	Ethernet	14
6.11	Power over Ethernet	15
6.12	SDRAM	15
6.13	Quad-SPI NOR Flash memory	15
6.14	Virtual COM port	15
6.15	RGB LCD display	15
6.16	Buttons and LEDs	16
7	Connectors	17
7.1	ARDUINO® Uno V3 connectors	17
7.2	CN13 USB OTG_FS Micro-AB connector	18

7.3	CN1 Ethernet RJ45 connector	18
7.4	LCD RGB connector	19
7.5	CN2 STMod+ connector	20
7.6	CN14 STLINK-V3 USB Micro-B connector	20
7.7	Audio stereo speaker header connectors (CN17 and CN18)	20
7.8	CN9 audio line output (green jack) connector	20
7.9	CN8 audio line input (blue jack) connector	21
7.10	CN16 TAG connector	21
7.11	CN4 STDC14 connector	21
7.12	CN15 USB power connector	22
8	STM32H745I-DISCO and STM32H750B-DK I/O assignment.....	23
9	STM32H745I-DISCO and STM32H750B-DK product information.....	30
9.1	Product marking	30
9.2	STM32H745I-DISCO product history	30
9.2.1	Product identification DKH745IO\$AT1	30
9.3	STM32H750B-DK product history	30
9.3.1	Product identification DK32H750B\$AT1	30
9.4	Board revision history	31
9.4.1	Board MB1381 revision B-01	31
Appendix A	Federal Communications Commission (FCC) and Industry Canada (IC) Compliance Statements.....	32
A.1	FCC Compliance Statement	32
A.2	IC Compliance Statement	32
Appendix B	CE conformity	33
B.1	Warning	33
	Revision history	34
	Contents	35
	List of tables	37
	List of figures.....	38

List of tables

Table 1.	List of available products	3
Table 2.	Codification explanation	3
Table 3.	ON/OFF convention	5
Table 4.	Power-supply related jumper and solder bridge settings	13
Table 5.	Ethernet-related solder bridge and resistor settings	15
Table 6.	Assignment of control ports to LED	16
Table 7.	ARDUINO® connectors (CN2, CN3, CN6, and CN7).	17
Table 8.	CN13 USB OTGFS micro-AB connector	18
Table 9.	CN1 Ethernet RJ45 connector	18
Table 10.	LCD RGB connector.	19
Table 11.	CN2 STMod+ connector	20
Table 12.	CN14 USB Type-B connector	20
Table 13.	CN16 TAG connector	21
Table 14.	STDC14 connector	21
Table 15.	CN15 USB Micro-B connector	22
Table 16.	STM32H745I-DISCO and STM32H750B-DK I/O assignment	23
Table 17.	Document revision history	34

List of figures

Figure 1.	STM32H745I-DISCO and STM32H750B-DK boards (top view)	1
Figure 2.	STM32H745I-DISCO and STM32H750B-DK boards (bottom view)	1
Figure 3.	Hardware block diagram	7
Figure 4.	STM32H745I-DISCO and STM32H750B-DK Discovery board top layout	8
Figure 5.	STM32H745I-DISCO and STM32H750B-DK Discovery board bottom layout	9
Figure 6.	STM32H745I-DISCO and STM32H750B-DK Discovery board mechanical drawing (bottom view)	10
Figure 7.	CN13 USB OTG Micro-AB connector (front view)	18
Figure 8.	CN1 Ethernet RJ45 connector (front view)	18
Figure 9.	LCD RGB connector (footprint)	19
Figure 10.	CN14 USB Micro-B connector (front view)	20
Figure 11.	CN16 TAG debugging connector (top view)	21
Figure 12.	CN15 USB Micro-B connector (front view)	22

IMPORTANT NOTICE – PLEASE READ CAREFULLY

STMicroelectronics NV and its subsidiaries (“ST”) reserve the right to make changes, corrections, enhancements, modifications, and improvements to ST products and/or to this document at any time without notice. Purchasers should obtain the latest relevant information on ST products before placing orders. ST products are sold pursuant to ST’s terms and conditions of sale in place at the time of order acknowledgement.

Purchasers are solely responsible for the choice, selection, and use of ST products and ST assumes no liability for application assistance or the design of Purchasers’ products.

No license, express or implied, to any intellectual property right is granted by ST herein.

Resale of ST products with provisions different from the information set forth herein shall void any warranty granted by ST for such product.

ST and the ST logo are trademarks of ST. For additional information about ST trademarks, please refer to www.st.com/trademarks. All other product or service names are the property of their respective owners.

Information in this document supersedes and replaces information previously supplied in any prior versions of this document.

© 2021 STMicroelectronics – All rights reserved