

CSC258H: Logisim-Evolution Reference

Alexander Klemenchuk (last updated by Larry Zhang, January, 2021)

1 Introduction

Logisim is a powerful logic circuit simulation environment. In CSC258, we will use Logisim-Evolution (a fork of the original Logisim) Version 3.4.1. To obtain the software, go to the following link:

<https://github.com/reds-heig/logisim-evolution/releases/tag/v3.4.1>

and download `logisim-evolution-3.4.1-all.jar`. **Note:** Make sure to use Logisim-Evolution downloaded at the above link. Do NOT use the original Logisim or any other variations of it.

Note: The images in this document was taken from an older version of Logisim Evolution (2.15), therefore some of them might look different from the current version of the software. We expect that the differences would not cause significant confusion. However, please let us know if you think any part is unclear and we will make updates accordingly.

To launch the program, simply double click on `logisim-evolution.jar` on most operating systems with a working Java installation (**use Java version 9 or newer**). You might need to perform a `chmod +x logisim-evolution.jar` command to make the file executable. If you have issues with the scaling of the interface on high resolution displays, it may be worth it to try updating Java to version 9 or higher.

Logisim works with `.circ` files. There is one `.circ` file per “project”. You can add multiple circuits to the same file. Since the software is easy to run on any computer and the files are portable, it’s easy to work from home!





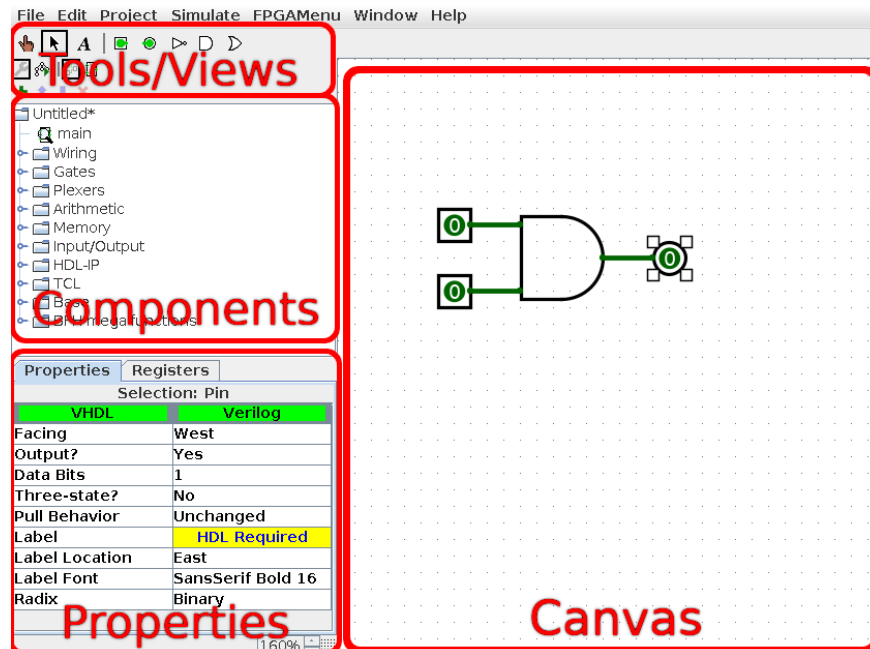



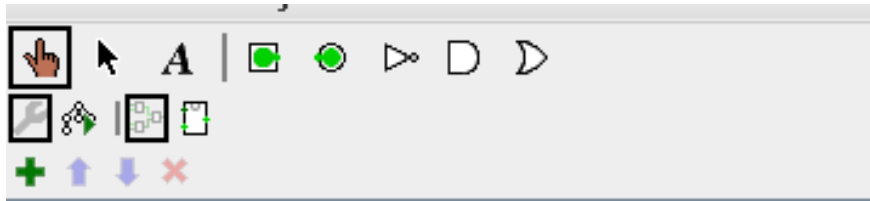



For a tutorial walking through the basics of how to make a simple circuit in Logisim, in the menu-bar click Help → Tutorial

2 The Interface



2.1 Tools and Views



-  “Poke” tool: Click on wires to inspect their state, click on most components to change their state.
-  “Select” tool: Selects and moves things in the canvas, and manipulates wires/buses. Click and drag from inputs/outputs to create wires/buses. Click to select individual wire segments. Click and drag from an empty region to box-select components. Keep in mind, overlapping wires and inputs will always connect, so be careful! You can also click and drag the end of wire segments to detach them from components. **You can also hold shift while clicking and dragging a component to leave connections behind.**
-  Text tool. Click to add text.
- On the top row there are also shortcuts to commonly used components. Like the input pin () and the output pin () This can be customized in **Project** → **Toolbar**.
- The  button views the components list, and the  button views the simulation hierarchy (this is not important for the course).
- The  button views the circuit in the canvas and the  button views the circuit symbol so you can customize how it looks as a sub-circuit.
- The  button adds a new circuit,   move circuits up and down in the list, and  deletes a circuit.

2.2 Properties

A screenshot of the 'Properties' window in a software interface. The window has two tabs: 'Properties' and 'Registers'. The 'Properties' tab is active, showing a table for 'Selection: Pin'. The table has two columns: 'VHDL' and 'Verilog'. The 'Facing' property is set to 'East'. The 'Output?' property is set to 'No'. The 'Data Bits' property is set to '2'. The 'Three-state?' property is set to 'No'. The 'Pull Behavior' property is set to 'Unchanged'. The 'Label' property is set to 'my_input'. The 'Label Location' property is set to 'North'. The 'Label Font' property is set to 'Comic Sans MS Bo...'. The 'Radix' property is set to 'Binary'. To the right of the table is a preview of the component in the canvas, showing a pin symbol with the label 'my_input' and a wire connected to it.

This section of the interface allows you to customize the currently selected component in the canvas. This Pin is configured to have two data bits (bus), is an output pin, and has a customized label.

2.3 Wire Coloring

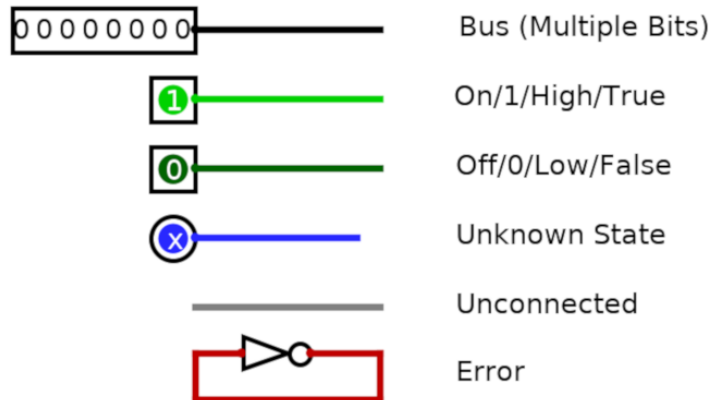

Wires and buses can have many states. You can inspect the state of a wire/bus using the “poke” tool available in the toolbar.

2.4 Components

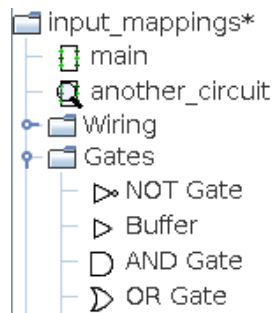

This contains all the circuits in this file as well as all the built-in components.

Double-click on each circuit to view it. To place a component from this list, select it, and then click somewhere in the canvas.

2.5 Sub-Circuits (Using a circuit in another circuit)

All circuits you make are automatically components, appearing in the components pane at the top of the list. This means you can use a circuit in another circuit by placing it just like any other component.

To add another circuit to the project, either click on the plus button above the components pane, or right click on the folder icon with the name of your file and select “Add Circuit”.

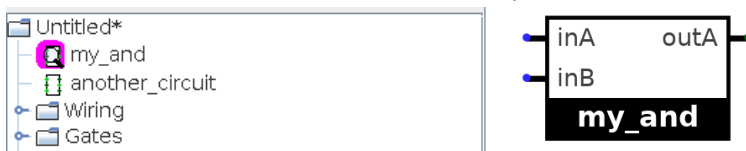

This is the default appearance of a sub-circuit, this can be customized by clicking the “Edit circuit Appearance” button in the Tools/Views pane.

Note: Only named Pin input and outputs will be accessible from the circuit that uses the symbol.

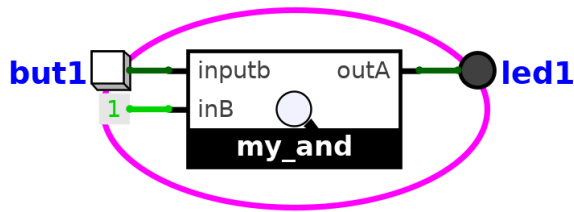

Using the “poke/hand” tool from the toolbar you can double click on the center (the magnifying glass) and see what the subcircuit is doing with that input/output! This is a live view, so clocks will keep updating from the outer circuit.

3 Buses

Buses are wires that contain multiple bits. Buses are created automatically when wires are connected to components that have multi-bit inputs or outputs. Buses can be split into smaller buses or individual wires with a **Splitter**. Here is an example using both:

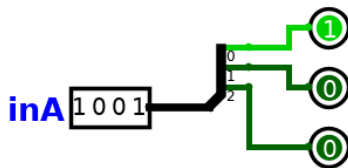

Here, I have connected a multi-bit input **Pin** to a splitter, then to three single bit output pins. The input is 4-bits “wide” as I have set the **Data Bits** property to 4.

To edit the value in the input **Pin**, you can use the “Poke” tool, clicking to toggle bits.

Properties		Registers	
Selection: Splitter			
VHDL		Verilog	
Facing	East		
Fan Out	3		
Bit Width In	4		
Appearance	Left-handed		
Bit 0	0 (Top)		
Bit 1	1		
Bit 2	2 (Bottom)		
Bit 3	None		

The splitter takes in a 4 bit input as it’s **Bit Width In** is set to 4. It splits it into 3 wires, as it’s **Fan Out** is set to 3. Bit 0 of the input is sent to output 0, 1 to 1, 2 to 2, and bit 4 is sent nowhere. If you send multiple bits to the same output, that output becomes a bus.

Splitters work both ways! In this example, the inputs and outputs could be switched.





4 Component Descriptions

Far more detailed descriptions are also available in [Help → Library Reference](#)





The following is a list of the components that bear mentioning.

4.1 Wiring

- **Splitter**: Splits buses into individual wires or smaller buses. Works both ways.
- **Pin**: Appears in sub-circuit symbols, mappable to inputs/outputs on DE-2 board if input/output respectively. Like most components, has a configurable number of bits.

-  **Clock:** Toggles when you press **Ctrl+T**, can toggle on a timer by going into the **Simulate** dropdown in the menu-bar, **Ticks Enabled** turns this on and **Tick Frequency** controls how fast it ticks. This works on the DE-2 board!
-  **Probe:** Can be attached to a wire to display its state.
-  **Tunnel:** Tunnels with the same label are connected to each other.
-  **Constant:** Outputs a constant value (can be multiple bits on a bus).
-  **Bit Extender:** Pads or sign extends bits on a bus.

4.2 Input/Output

-  **Button:** Can be mapped to the switches and buttons on the DE-2 board. Only outputs a 1 when held down with the  “poke” tool.
-  **Dip switch:** Can be mapped to the switches and buttons on the DE-2 board. Is multiple switches in one.
-  **7-Segment Display:** Can be mapped to the 7-segment display on the DE-2 board. More information below.
-  **LED:** Can be mapped to the outputs on the DE-2 board.

4.3 7-Segment Display

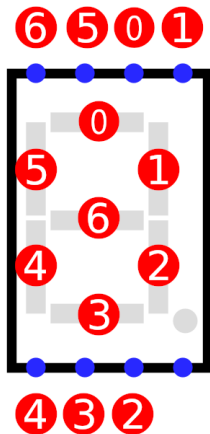

Above is the mappings of the pins to segments of the 7-segment component.

The 7-segment display can be mapped to any the displays on the DE-2 board. The decimal point can not be mapped as it is not connected.

4.4 ROM

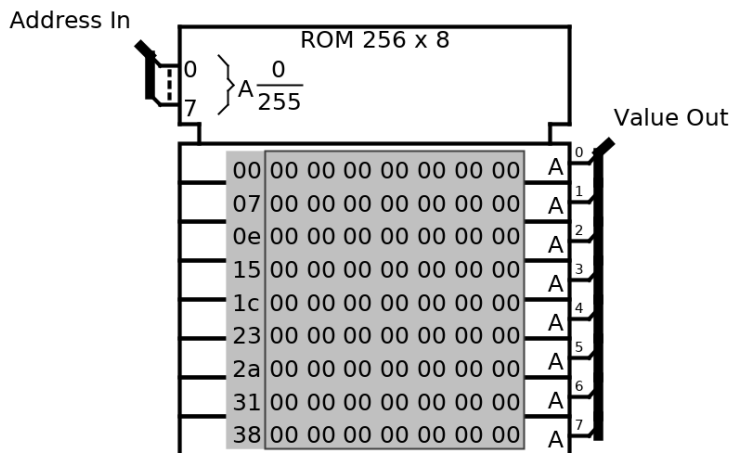

Use the “poke” tool to select a memory cell and type a value in hexadecimal.

You can right click and “Edit Contents” to open a full editor that views the contents as hexadecimal and has options to save it as a file that can be loaded later.

This block works on the DE-2 board!

Note on a possible bug: If you move the ROM block before editing it’s contents in the canvas, buggy behavior might happen. To fix this, if you get issues with the ROM block, simply reset the simulation with Simulate → Reset Simulation or hit Ctrl+R

5 Best Practices

5.1 Naming Inputs/Outputs

Not only will this create more usable circuit symbols, and allow you to program the DE-2 board, but it also helps read your circuit.

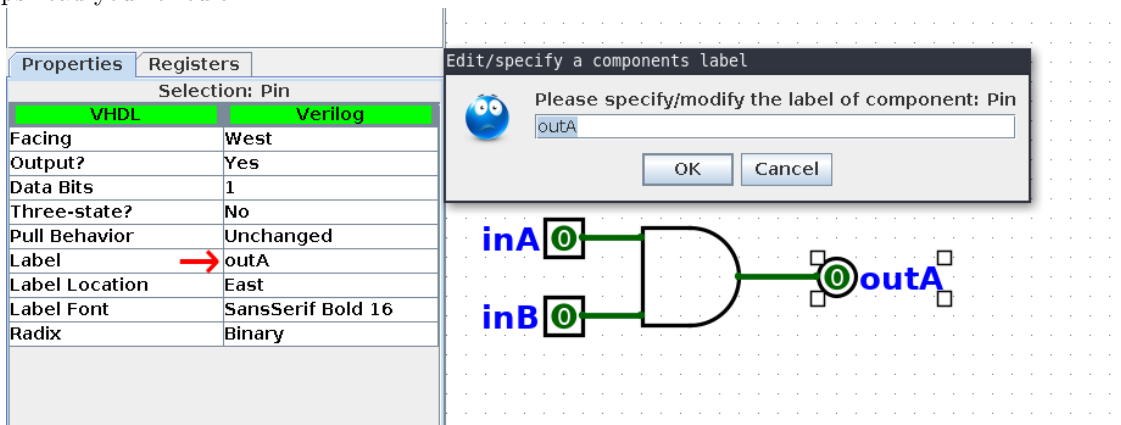

To give a component a name, either double click on it, change the Label property in the Properties window, or hit the Annotate button when about to program (see later).

5.2 Naming Circuits

It’s important to give your circuits/sub-circuits good names.

To rename a circuit, click on the circuit in the components list, and edit it’s Circuit Name property.

5.3 Sub-Circuit tips

- Use sub-circuits any time you find yourself repeating a pattern in a circuit

- Don't use any other input/output device in a sub-circuit other than Pin. They won't show up in outer circuits and are a nuisance when programming the board.

6 Programming the Board

6.1 FPGA Configuration

To be able to program the DE-2 boards, Logisim needs to have the DE-2 configuration file loaded, a directory to put project files configured, and the path to the compiler.

On the menu bar, select **FPGAMenu**, then choose **FPGA Commander** to open this menu.

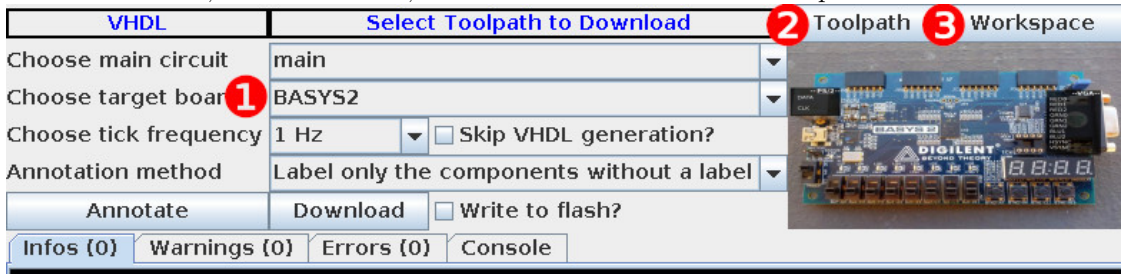

1. Choose target board → Other → browse to ALTERA_DE2.xml that you downloaded (from the course website) → hit Open.
2. Toolpath → type /opt/altera/11.1sp2/quartus/bin in Folder name → hit Open. This path is for the lab computers and it may vary on other computers.
3. Workspace → browse to folder where Logisim will put Quartus project folders when compiling (don't just choose your home folder, make a new one) → hit Open

6.2 Preparing to Program

NOTE: To program the board, Logisim needs names for your inputs and outputs.

To program the board, on the menu bar select **FPGAMenu**, then choose **FPGA Commander**.

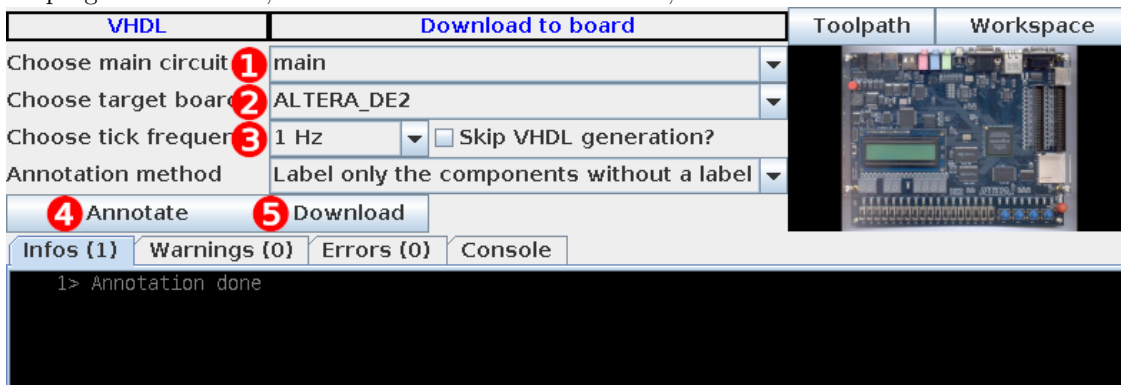

Starting the programming process usually just needs a quick press of the **Download** button, but here's what everything here means:

1. Choose main circuit should be the top level circuit you want to program to the board. (Defaults to last active circuit)
2. Choose target board should be ALTERA_DE-2

3. Choose **tick Frequency** sets how fast the **Clock** component toggles. 1 Hz means the clock cycles LOW-HIGH once per second. All **Clock** components share the same clock.
4. **Annotate** will label components (by default, only components without a name).
5. **Download** will start the board programming process.

6.3 Pin Mappings

Components like: **Button**, **Dip switch**, **Pin** (square shape when input) are considered inputs and can be mapped to the buttons and switches on the DE-2 board. Components like: **7-Segment Display**, **LED**, **Pin** (circle when output) are considered outputs and can be mapped to the 7-segment display and the LEDs.

Unmapped List:	Mapped List:	Command:
PIN: /inA#Button0	BUTTON: /Button_1	Release component
PIN: /inB#Button0	LED: /LED_1	Release all components
PIN: /outA#LEDO		Load Map
		Save Map
		Cancel
		Done

1.0x 1.5x 2.0x

No messages

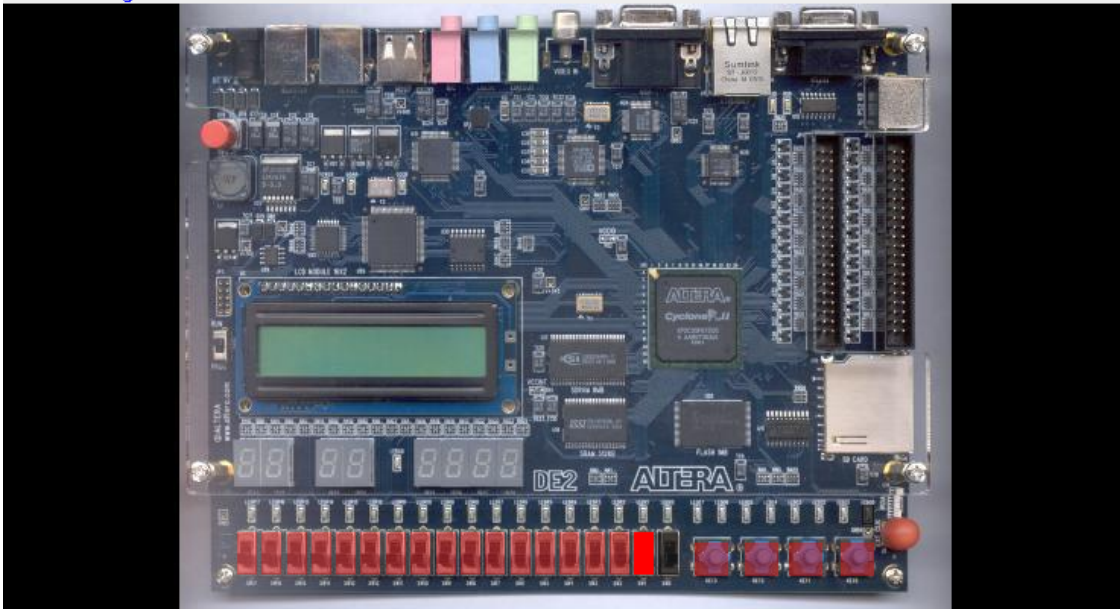

We need to map our input and output devices to things on the real DE-2 board. To do this, click on a input/output in the **Unmapped List**. Components that this can be mapped to are highlighted in translucent red. Click on one of these to map the device. The next device is automatically selected.

Save Map and **Load Map** lets us save these mappings to load them the next time we want to use the same ones. **Done** starts the compiling process.

Once it's done compiling, we get this:

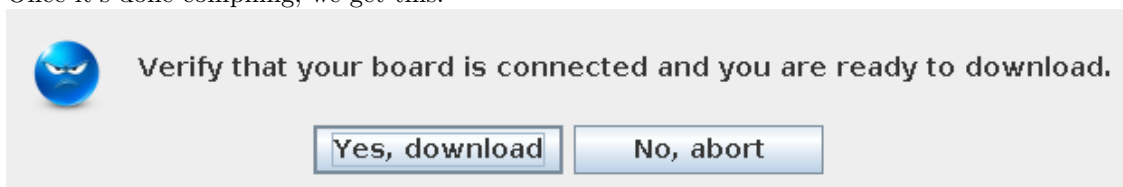

Lets get the physical device ready to program

6.4 Physical Board Setup

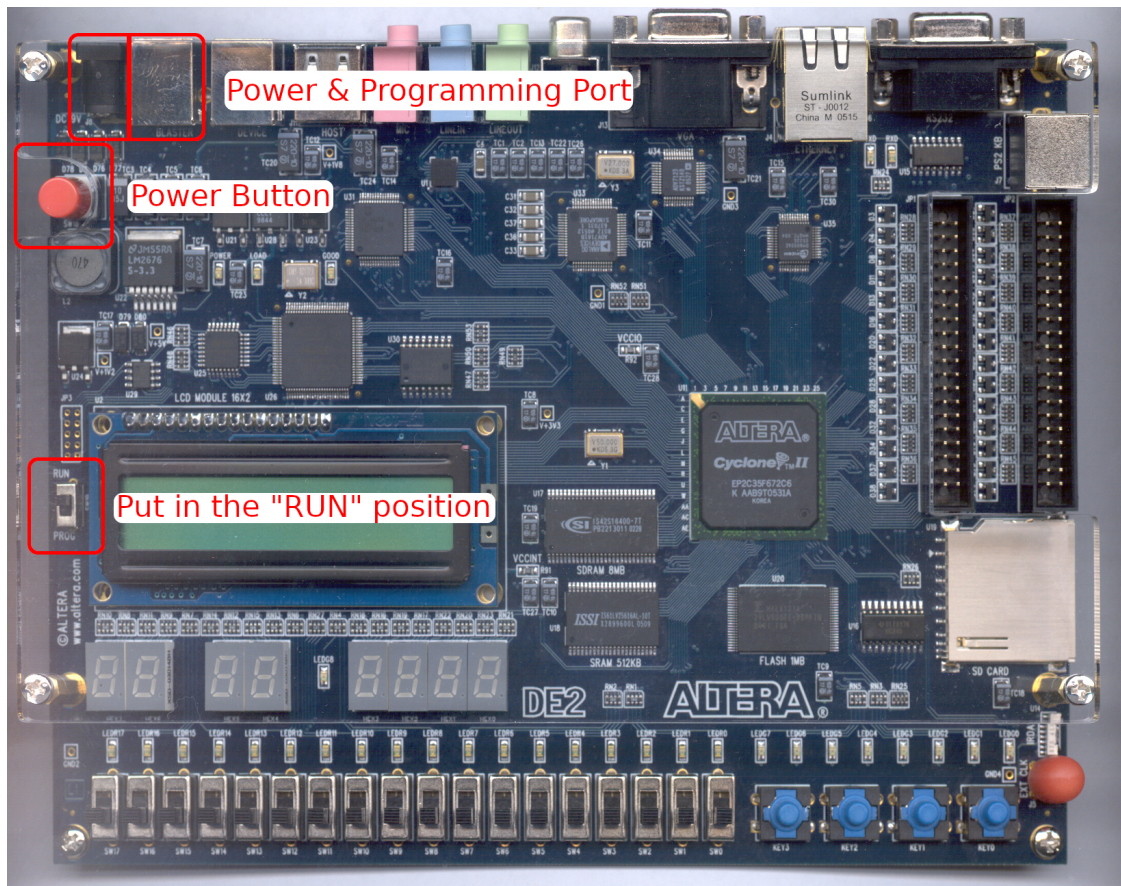

Make sure you plug the USB cord into the port labeled “BLASTER” not “DEVICE”, and make sure the switch on the left hand side is put in the “RUN” position.

Then hit “Yes, download”, and your board should light up with the genius circuit you came up with!