



Vhodno izhodne naprave

Laboratorijska vaja 1 - VP 1
Uvod v VINProjekt, tipala,
TinkerCad simulacije

VIN projekt - VP1: Uvod, tipala, TinkerCad osnove

- Uvod v VIN projekt
- Tipala
- Spoznavanje TinkerCad-a
- Domača naloga (DN2-VP1)

VIN projekt - VP1: Uvod, tipala, TinkerCad osnove

- Uvod v VIN projekt
- Tipala
- Spoznavanje TinkerCad-a
- Domača naloga (DN2-VP1)

VIN projekt

■ Izhodišči

- Spoznavanje **delovanja vhodno izhodnih naprav**
 - Povezave: Mikrokrmilnik, tipala, tipke, LED diode, ...
- Analiza/izvedba **komunikacije** med vgrajenimi sistemi oz. tipali
 - 1-Wire, SPI, I2C, RS232, CANBUS, RS485, MODBUS, ...

■ Metode:

- **Priprava (po potrebi): Tinkercad** simulacija in priprava kode (po potrebi)
- **Izvedba na pravem sistemu**
 - Osciloskop, STM32, tipala, „breadboard“, prototipi – npr. „pametna hiška“

■ Predstavitev, poročilo:

- **(živa predstavitev 5min)**
- **poročilo** v obliki gradiva, objave na blogu (povzetek, poster, video)
- **video (do 2min) in grafična predstavitev („poster“, skica, miselni vzorec)**

VIN Projekt – Delo MS Teams

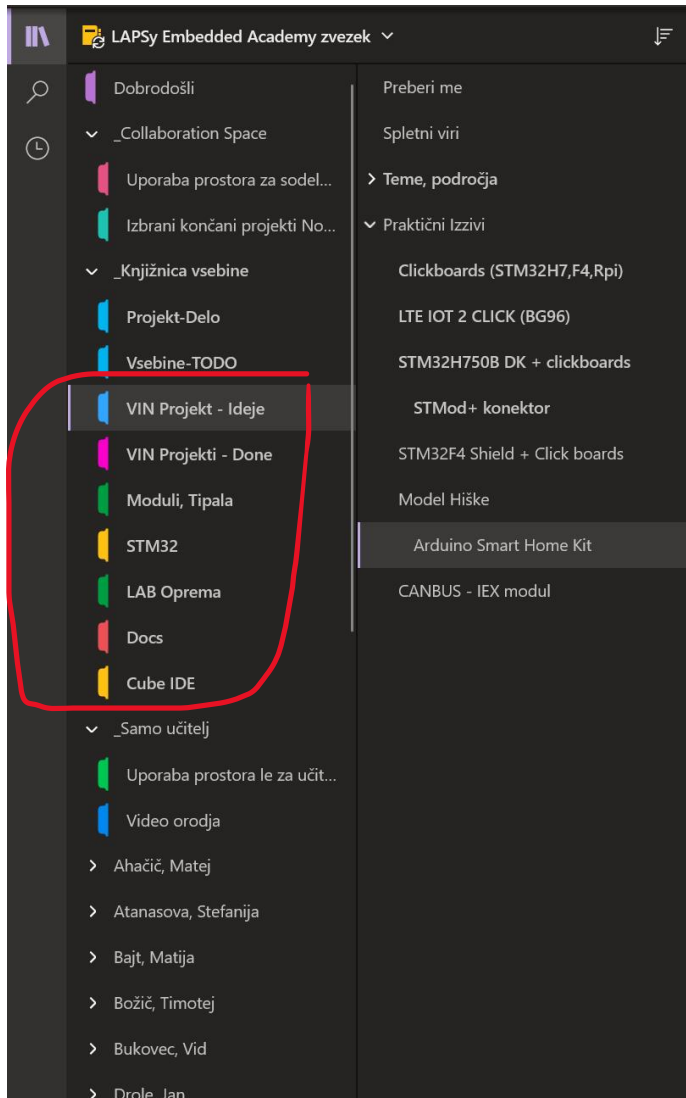

Arduino Smart Home Kit

torek, 02. marec 2021 10:43



Assembling and testing - Keyestudio Smart Home Kit for Arduino

1,410 views
• Dec 12, 2020
292SHARESAVE

Z naslova <https://www.youtube.com/watch?v=W1p5159afc&ab_channel=HendrikxWorkshop>



Še nekaj **dodatnih izhodišč** za tiste, ki vas delo z mikrokrmilniki in senzorji zanima (vsako opravljeno in dokumentirano delo se tudi šteje kot dodatne naloge):

- Preveri delovanje **IR senzorja razdalje GP2D12** (razdaljo sporoča preko analognega izhoda – torej z vrednostjo napetosti):
 - https://www.swanrobotics.com/projects/gp2d12_project/
 - https://engineering.purdue.edu/ME588/SpecSheets/sharp_gp2d12.pdf
- Za mikrokrmilnik obstaja cela **zbirka različnih senzorjev (37)** in je na voljo v priročnem kompletu. Kar nekaj senzorjev lahko priključite na krmilnik Arduino, ali pa se seveda lahko inspirirate z objavljenimi projekti na spletu. Gradiv je res veliko.
- Še veliko več vseh ostalih virov najdete v MS Teams ekipi
 - LAPSy Embedded Academy group:
 - MS Teams
 - Koda za vstop: **ty5qjm9**

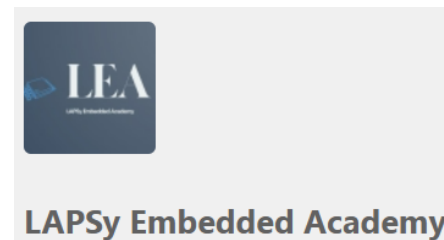

Simulacija: TinkerCad

Classes **Gallery** Blog Learn Teach Q

Serial Monitor
Distance (cm) : 106
Distance (cm) : 103
Distance (cm) : 94
Distance (cm) : 88
Distance (cm) : 84
Distance (cm) : 84
Distance (cm) : 84
Distance (cm) :

<https://www.tinkercad.com/>

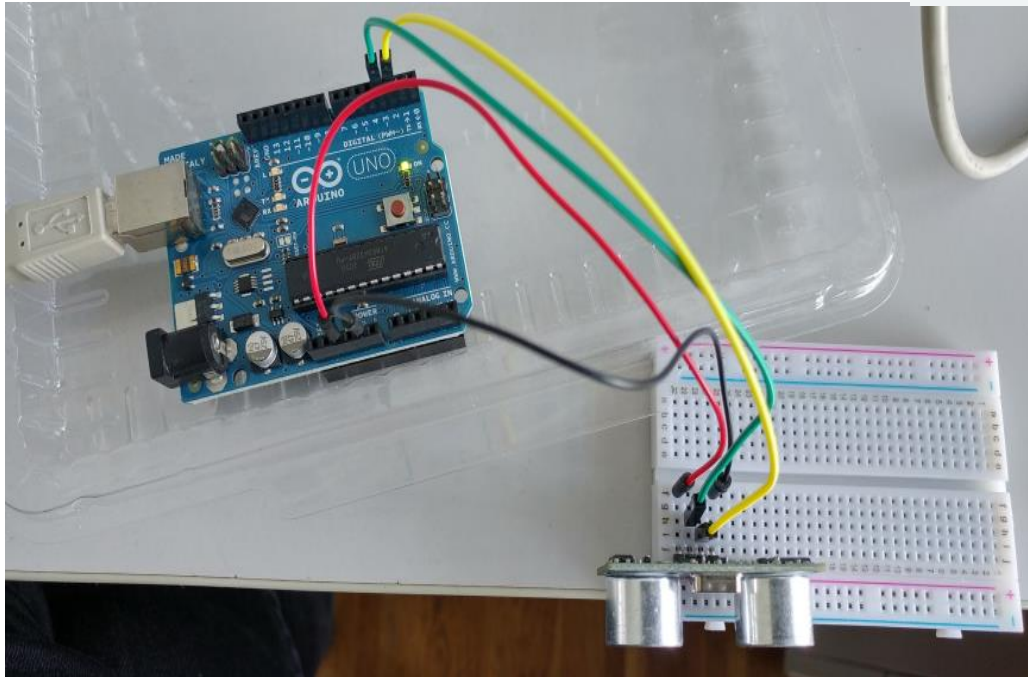
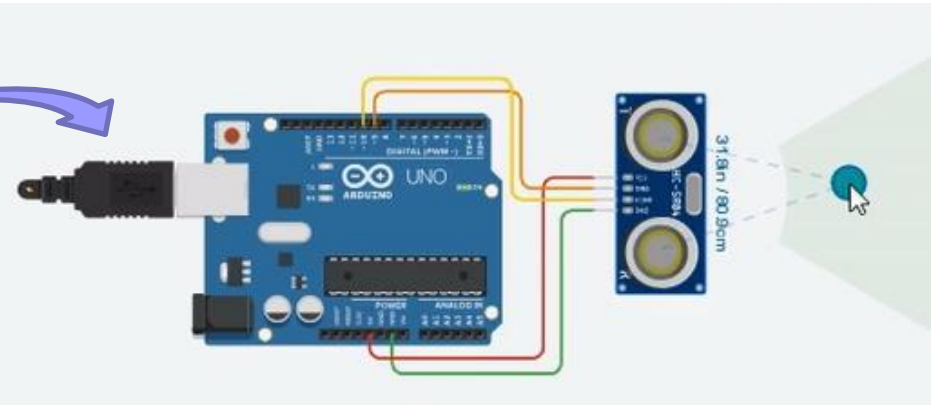

```
Text
12
13 void loop() {
14   digitalWrite(trigger_Pin, LOW); //
15   delay(1);
16   digitalWrite(trigger_Pin, HIGH);
17   delayMicroseconds(10); //Mak
18   digitalWrite(trigger_Pin, LOW);
19
20   duration = pulseIn(echo_Pin, HIGH);
21   distance = duration * 0.017; //(34
22   /* Speed of the sound in Air = 340 m/
23   * multiply it by 100 to get the data
24   * divide by 1,000,000 as duration is
25   * divide by 2 as ultrasound signal t
26   */
27   Serial.print("Distance (cm) : ");
28   Serial.println(distance);
29   delay(100);
30 }
```

Praktična izvedba (meritev)

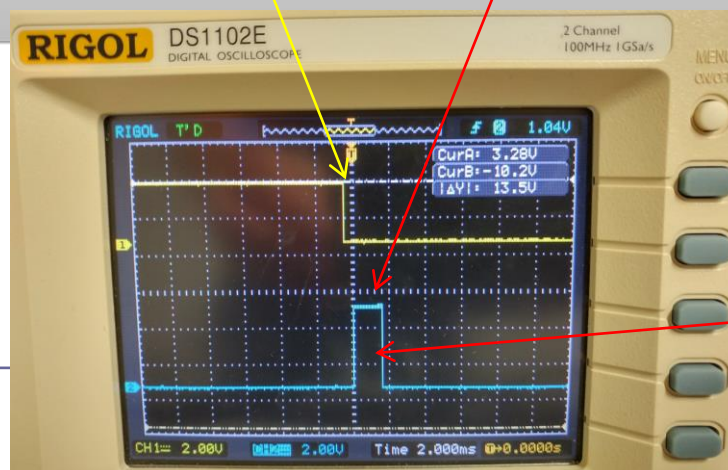
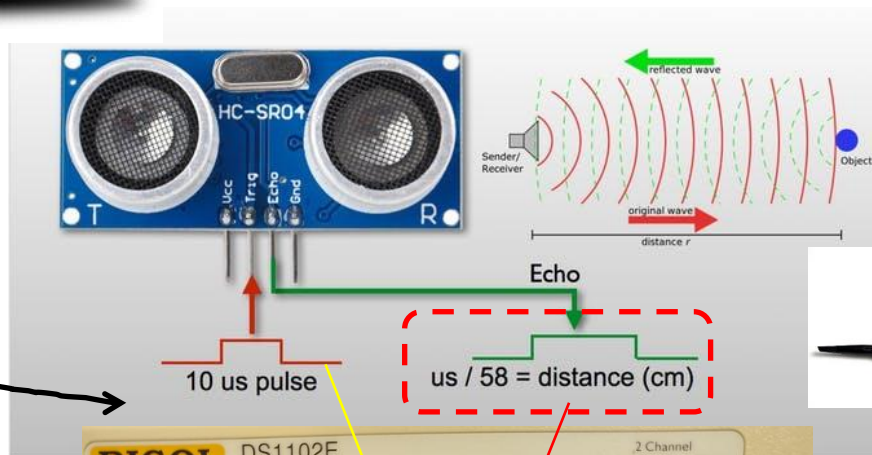
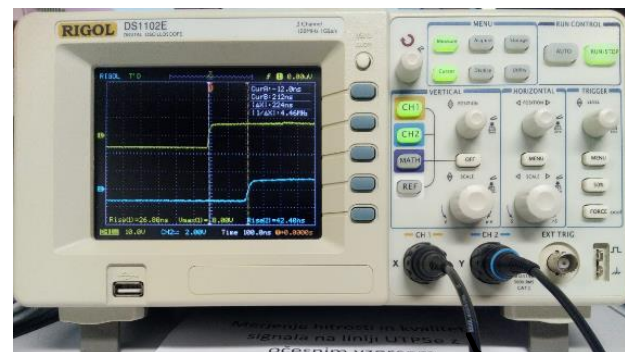
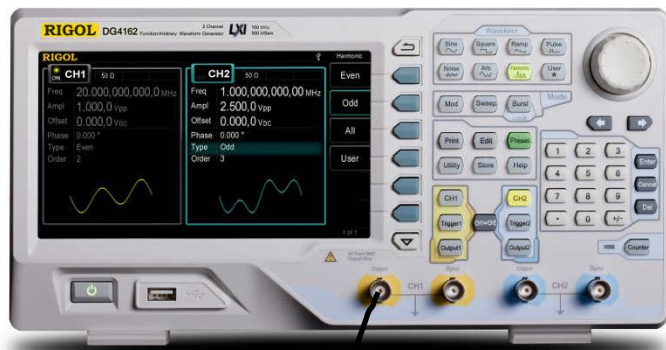

Oscilloskop - nastavitve
Measure -> Time -> Width

Simulacija (meritev)

UZ Senzor test



UZ Senzor test



Stop Simulation

Code

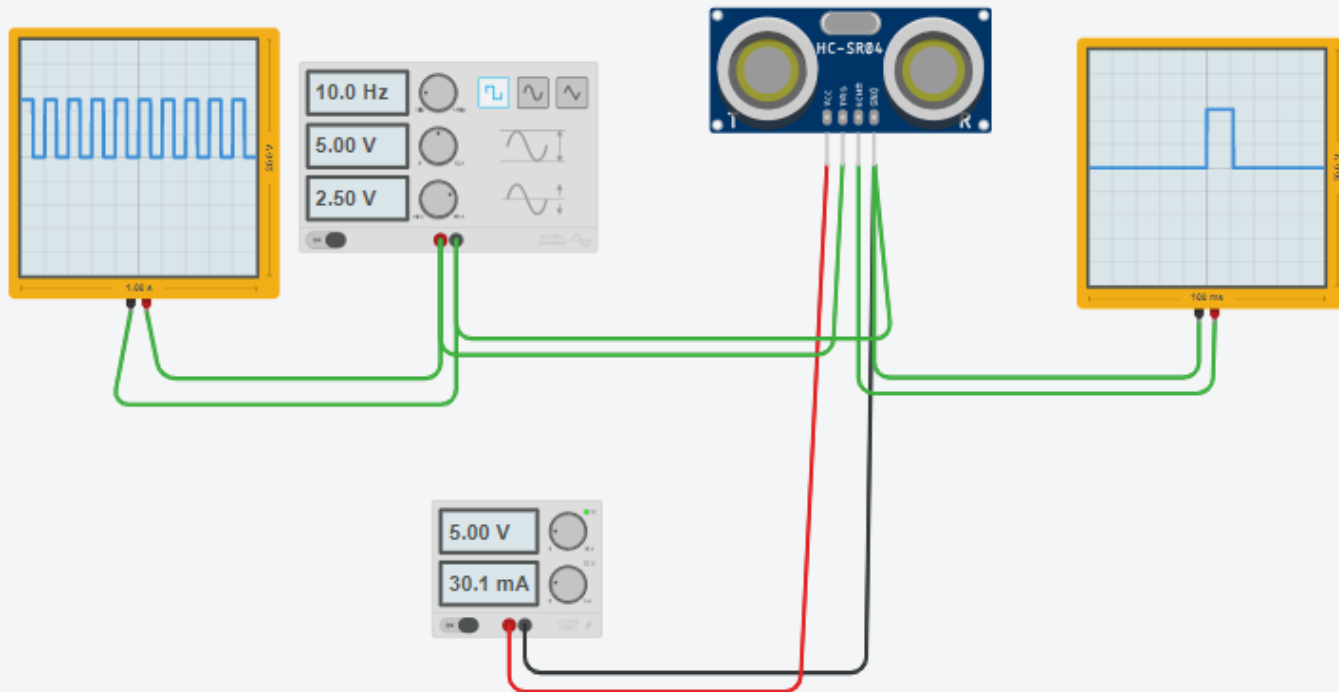

Predlog pristopa k VIN projektu :

- Raziščem delovanje osnovnih senzorjev (literatura), lahko DN1
 - Primer:
 - <https://www.circuito.io/blog/arduino-sensors-explained/>
- Naredim nekaj poskusnih projektov v TinkerCadu (po potrebi, DN2-VP)
 - spoznam se z okoljem
 - preizkusim nekaj osnovnih povezav
 - preizkusim napredne projekte s komunikacijo (mikrokrmilnik <-> tipalo)
- Fokusiram temo za svoj projekt
 - **Iskanje** po spletu, pregled izpostavljenih zanimivih projektov
 - Osnovna ideja sistema:
 - Načrt: mikrokrmilnik (STM32) kot centralni del sistema
 - Izvedba: STM32, povezan na nekaj tipal in komunicira ali prikazuje rezultate (USB, LCD, serijski vmesnik, ...)
 - Nadgradnje sistema (neobvezno)
 - Veliko idej, več mikrokrmilnikov, komunikacijski sistem (RS485, Canbus), povezava s PC (in naprej), ...
- Izvedba projekta (TinkerCad, CubeIDE), poročilo in predstavitev

Literatura (za praktično delo):

■ Valvano: Embedded Systems - Shape The World

knjiga (tudi PDF)

spletne vsebine:

■ EdX course:

<https://www.edx.org/course/embedded-systems-shape-world-utaustinx-ut-6-03x>

<https://www.edx.org/course/embedded-systems-shape-the-world-multi-threaded-in>

■ Ebook:

<http://users.ece.utexas.edu/~valvano/Volume1/E-Book/>

■ Zhu: Embedded Systems with ARM Cortex-M Microcontrollers in Assembly Language and C

Knjiga

Spletne vsebine (tudi youtube tutoriali) :

■ <https://web.eece.maine.edu/~zhu/book/>

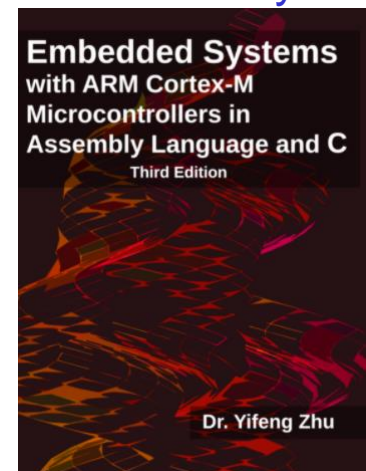
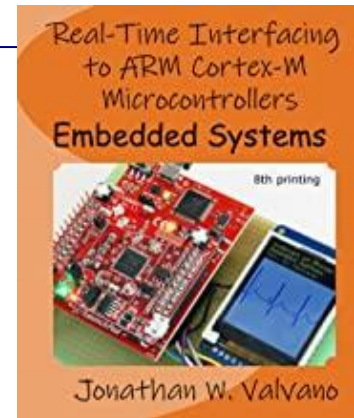

VIN projekt – izzivi

- Praktična realizacija projektov:
 - Npr. CANBus, Smarteh LPC, pametna hiša
- Praktični projekti – hiška :

Model je mišljen predvsem kot ena od idej za praktično izvedbo vaših projektov. Hiška je na poti na fakulteto in bo prisotna v našem laboratoriju.

Nabavil sem nekaj miniaturnega pohištva, da bo zgledalo bolj realno.

Ideja je hiško osvežiti, dodati nove naprave (razsvetljava, tipala) in narediti nek demo projekt/model pametne hiše

Nekaj slik :

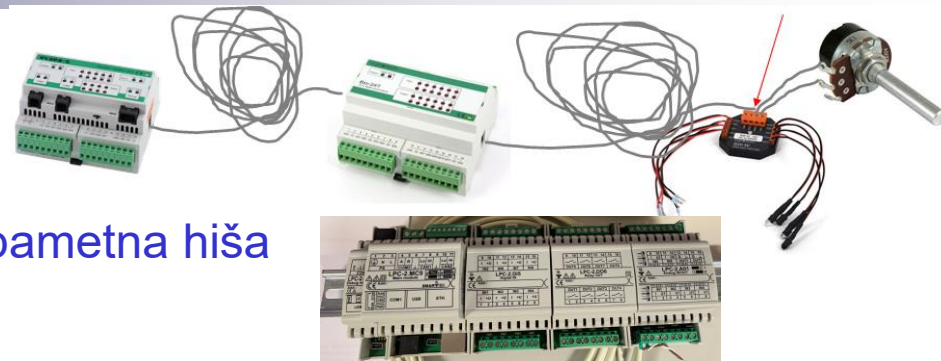
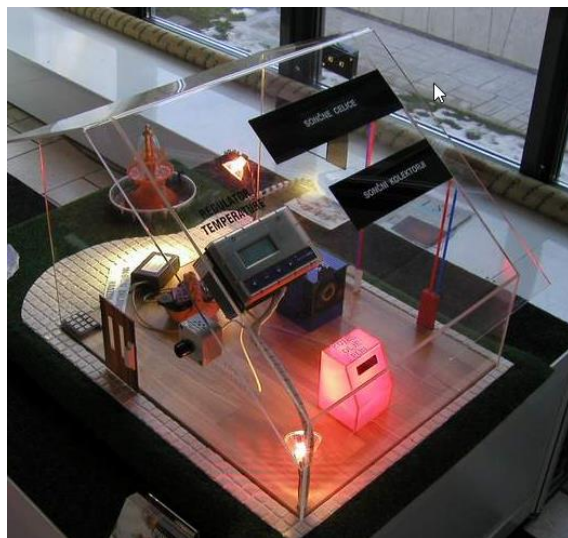

VIN projekt – izzivi

Multi-tipala

- LIR2 – Smarteh

- SensorTile.box

Vin projekt
Detekcija ljudi s senzorjem LIR2

Jakob Jelovčan

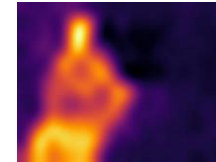

Jan Renar

Zaznavanje človeških aktivnosti s kombinacijo tipal na razvojni plošči
Sensortile.box

Bernard Kuchler

Uporaba modelov strojnega učenja v vgrajenih sistemih



Plug and play module for learning and developing
Ready to connect to Microsoft IoT services

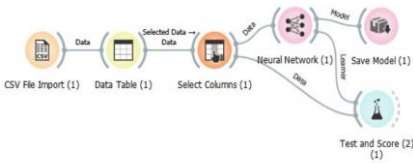

Slika 5.6: Povezava gradnikov v okolju Orange za izdelavo modela NN.

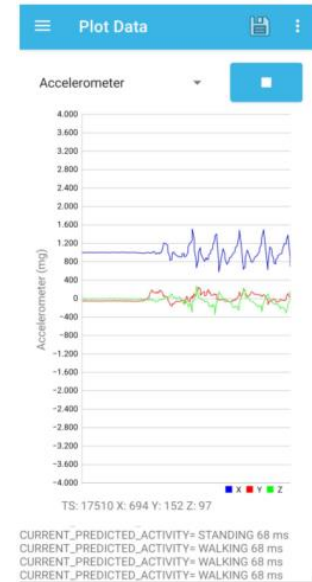
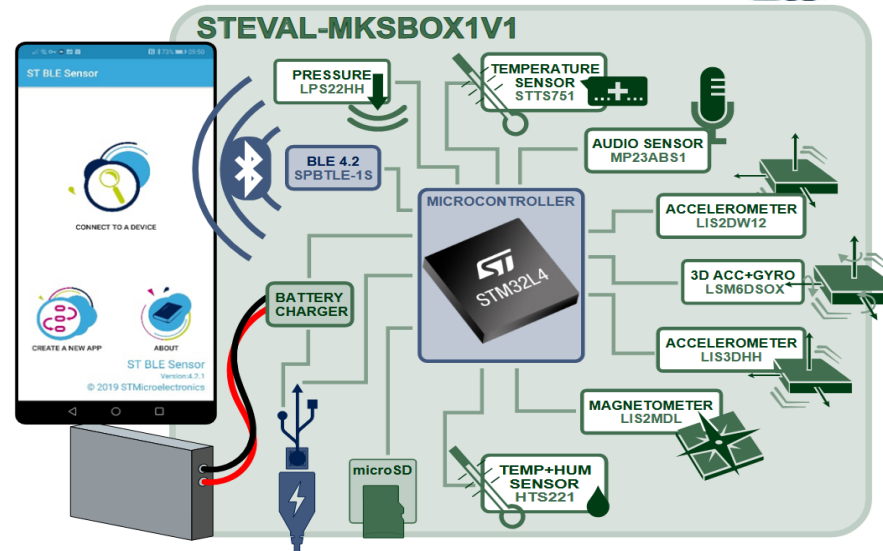
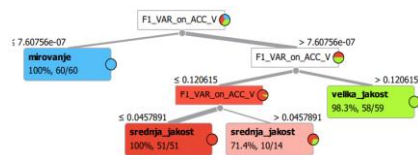

VP1: Uvod v VIN projekt



VP1: Uvod v VIN projekt

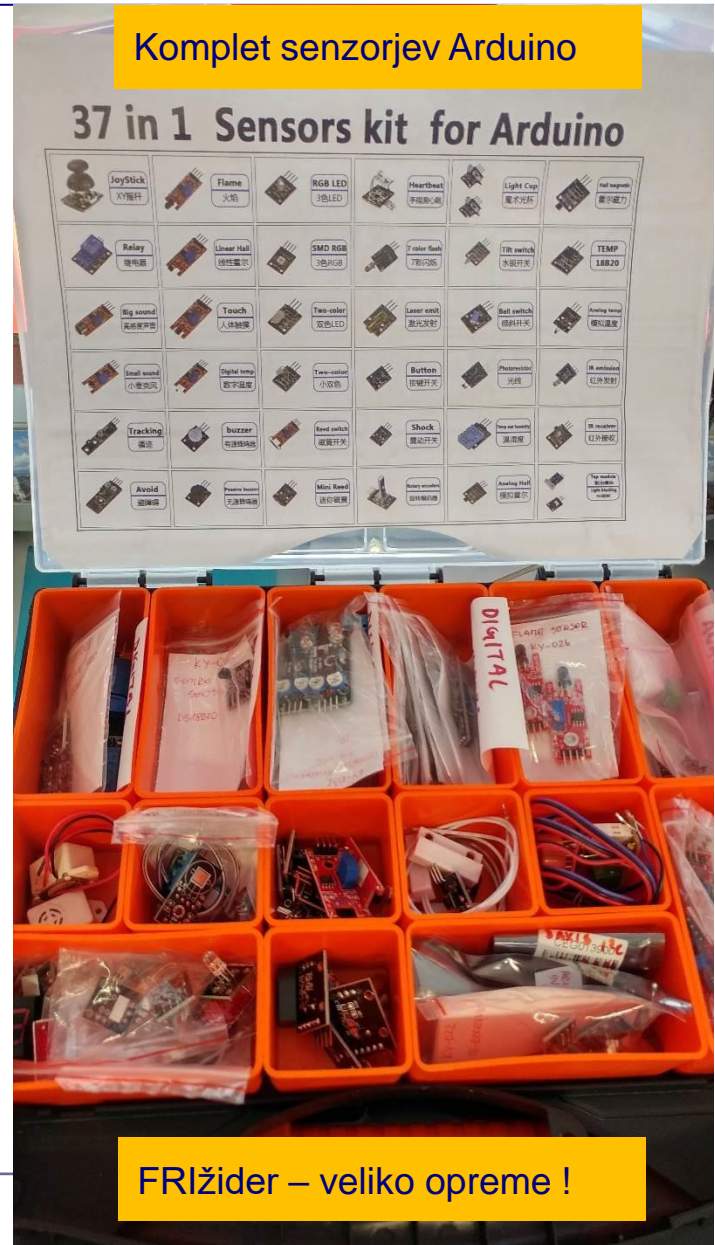





POŠTA DAMJAN



Predstavitev LAB-a

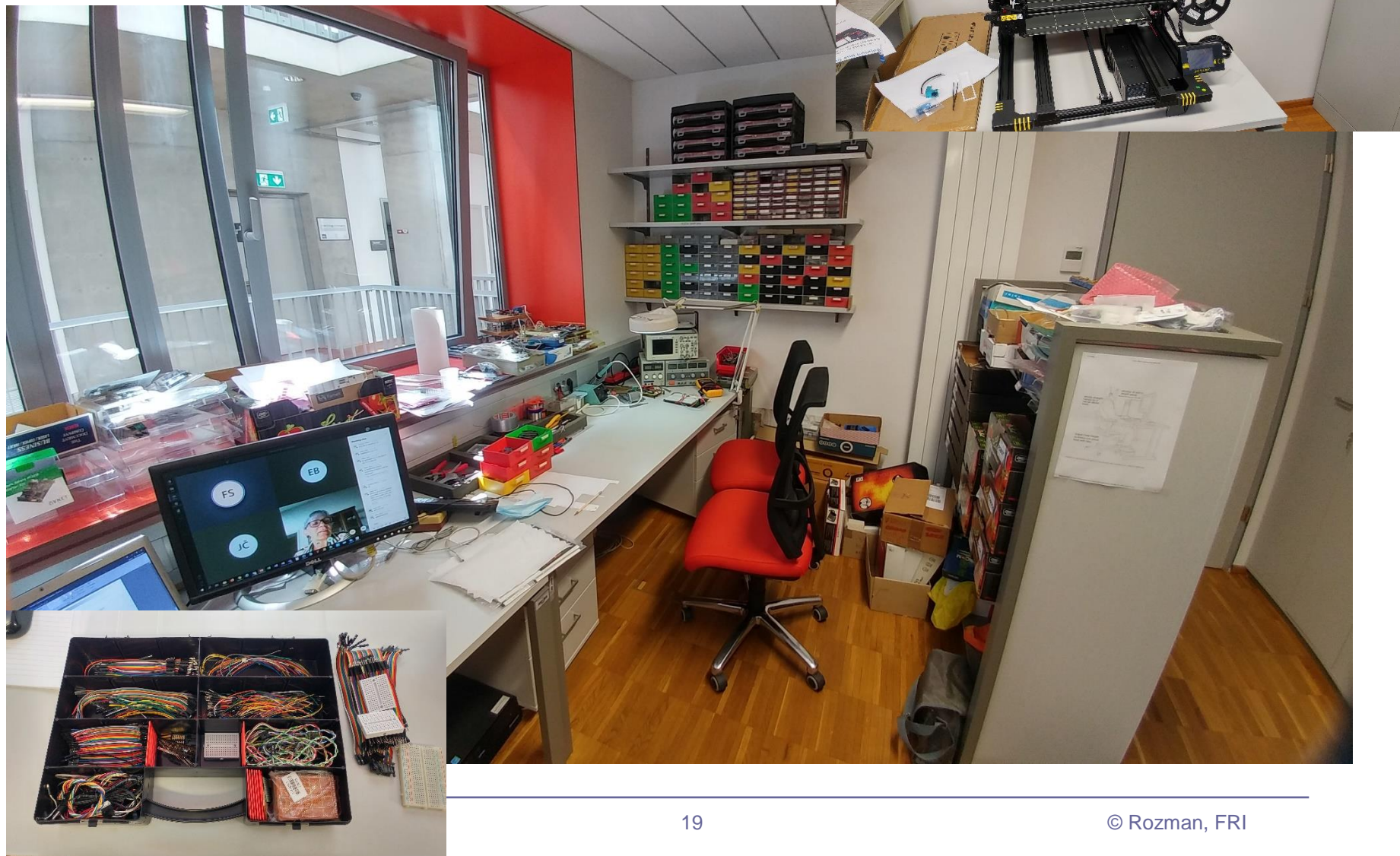

VP1: Uvod v VIN projekt – FRI Frižider



FRIžider – Arduino platforme



FRIžider - Tipala



VIN projekt - VP1: Uvod, tipala, TinkerCad osnove

- Uvod v VIN projekt

- Tipala

- Spoznavanje TinkerCad-a
- Domača naloga (DN2-VP1)

Tipala

Namen :

- Temperaturna tipala
- Tipala oddaljenosti
- Tipala svetlobe
- Tipala dotika/pritiska

Tehnologija :

- Tipala MEMS (Micro-Electro Mechanical Systems)

Priključitev :

- Analogni (uporovni, napetostni, tokovni)
- Digitalni:
 - 1/0, on/off (tipka, PIR, Reed, Tilt, ...)
 - Krmilnik + komunikacijski vmesnik (I2C, SPI, WiFi, 1-Wire, ...)

HOW ARDUINO SENSORS ACTUALLY WORK

<https://www.circuito.io/blog/arduino-sensors-explained/>

Temperature sensors



DHT22/11



am2320



BME680



DS18B20



DS18B20 Waterproof



TMP102

Distance sensors



LIDAR lite 3



HC-SR04



IR LED



MAX30105



A1302



GP2Y0A02YK0F

Force/Load sensors



Force sensitive resistor

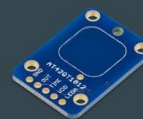

AT42QT1012



HX711

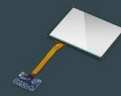

resistive touch screen



MPR121

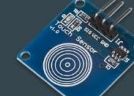

TTP223B

MEMS sensors



ADXL335



ADXL345



ITC-3200



HMC5883L



LSM9DS1



MPU-6050

Light sensors



ISL29125



GUVA-S12SD

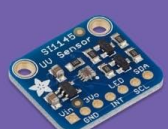

SI1145



LDR



ML8511



TCS34725

VIN projekt - VP1: Temperaturna tipala

Vrste :

- Termistorji
 - temp. odvisnost (snov)
- „Thermocouples“
 - Spoji kovin
 - Večji razpon, manjša natančnost
- RTD („Resistance Temp. Detector“)
 - Navitje prevodnega (temperaturno odvisnega) materiala



Priključitev :

- Analogni (uporovni)
- Digitalni:
 - komunikacija (I2C, SPI, 1-Wire, ...)

VIN projekt - VP1: Tipala oddaljenosti

Vrste :

- LIDAR
 - laser
- UZ tipala
 - Ultrazvok (npr. HC-SR04)
- IR (LED) tipala
 - IR svetloba, manjše razdalje
- Hall
 - Bližina magneta (brezkontaktni)

Priključitev :

- Analogni (Hall)
- Digitalni:
 - TOF (Time-of-Flight) meritev časa

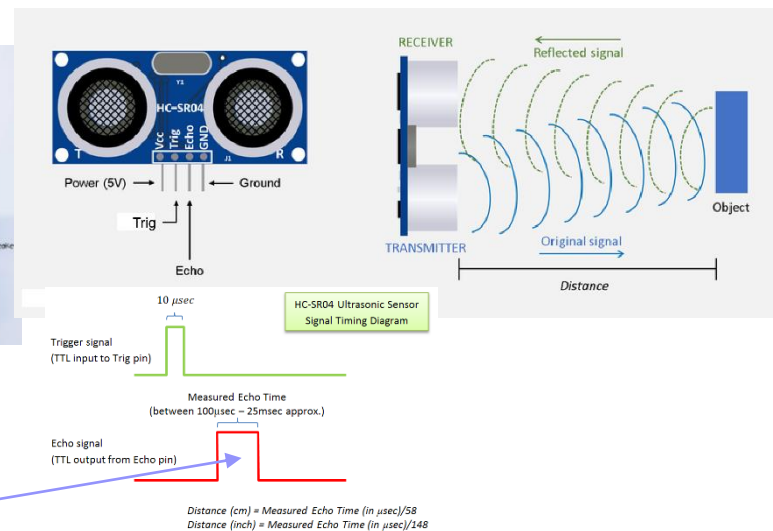
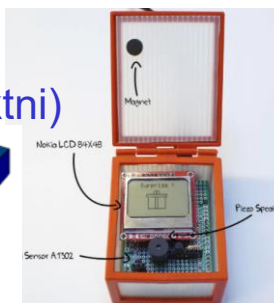
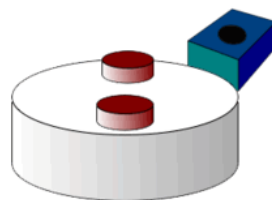

VIN projekt - VP1: Tipala MEMS

Vrste :

- Pospeškometri
 - Merijo pospeške v oseh
- Žiroskopi („Gyro sensors“)
 - Spremembe v kotni hitrosti (izračun kotov)
- Magnetometri
 - Merijo magnetno polje v 3 oseh

Priključitev :

- Analogni
- Digitalni
 - Protokoli (I2C, SPI, ...)

Pogosto skupaj:

- IMU („Inertial Measurement Unit“)
 - pospeškometer + žiroskop

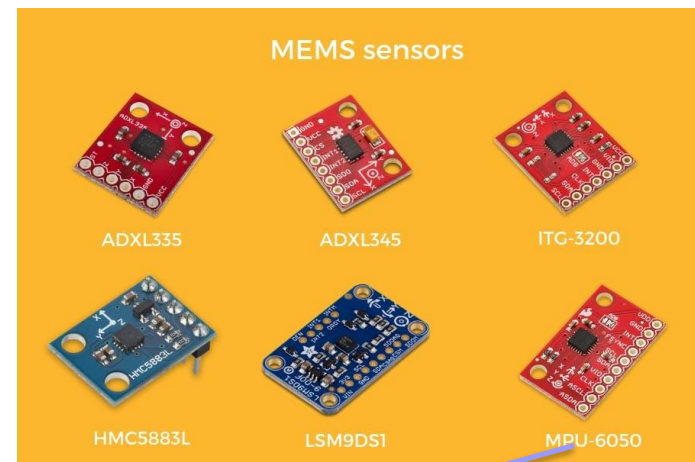

[How does an Accelerometer work? | 3D Animation](#)

LSM6DSOX

LSM6DSOX vsebuje 3D MEMS merilnik pospeška in 3D MEMS žiroskop. S pomočjo strojnega učenja lahko zmanjša porabo in izboljša zaznavanje. Poraba čipa je samo 0,55 mA.

Lastnosti

- Smart FIFO do 9 kbyte
- Združljiv z Androidom
- $\pm 2/\pm 4/\pm 8/\pm 16$ g polni obseg
- $\pm 125/\pm 250/\pm 500/\pm 1000/\pm 2000$ dps polni obseg
- Analogna napajalna napetost: 1,71 V do 3,6 V
- Neodvisno napajanje I/O (1,62 V)
- Velikost 2,5 mm x 3 mm x 0,83 mm

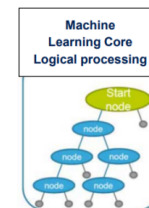
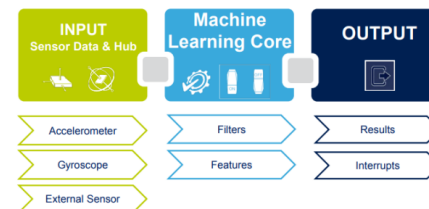

Slika 6 Jedro strojnega učenja v LSM6DSOX

VIN projekt - VP1: Tipala svetlobe

Vrste :

- LDR
 - Uporovno tipalo
- RGB
 - Meri „barvo“ odboja
- Specifične meritve
 - Npr. „vidni“ ali drugi spektri

Priključitev :

- Analogni (upornost, napetost)
- Digitalni
 - Protokoli (I2C,SPI, ...)

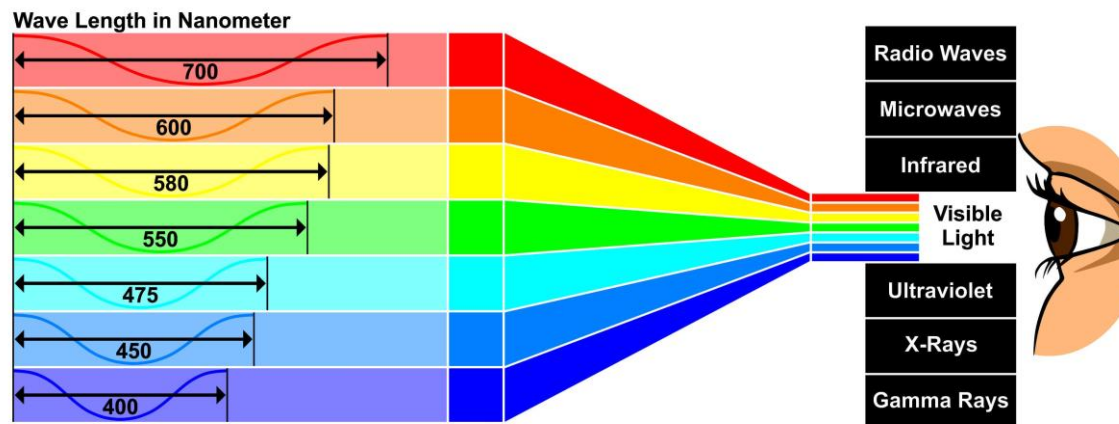

VIN projekt - VP1: Tipala dotika/pritiska

Vrste :

- Površine „na dotik“
 - uporovne
 - kapacitivne
- FSR („Force Sensing Resistor“)
 - Prevodna „goba“
 - veći pritisak → veća prevodnost
- „Load Cell“
 - bolj natančne, veći razpon obremenitev, dražje

Priključitev :

- Analogni
- Digitalni
 - Protokoli (I2C,SPI, ...)

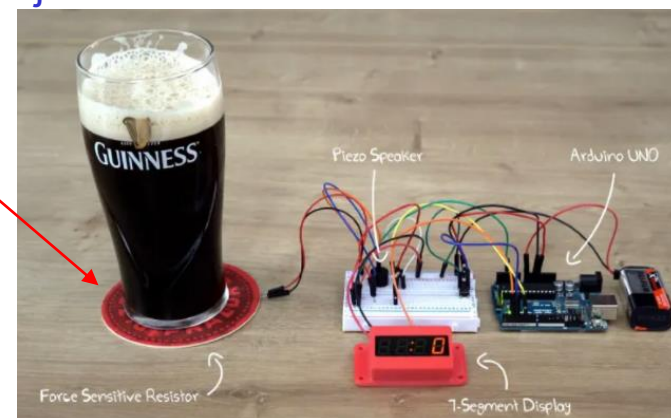
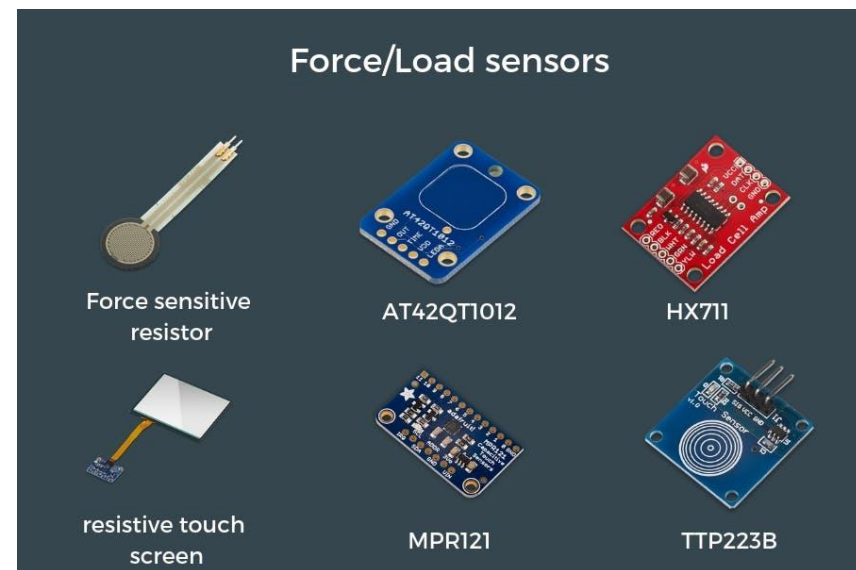

VIN projekt – tipala v LAPS

PIR Napion Senzor - OneNote

Isči

Rozman, Robert RR

Datoteka Osnovno Vstavjanje Risanje Zgodovina Pregled Ogled Pomoč

Izbor Izbira z lasom Dodaj pero Roka za vzdolžno premikanje Ravnilo Vstavi prostor ozadje Oblike Samodejne oblike Rokopis v besedilo Matematika Predvajanje rokopisa Pogled celotne strani Pomoč za iskanje rokopisa

Razveljavljaj Izbor Grobja za risanje Način vnosa Šablone Uredi Oblike Besedilo Besedilo Odgovori Način Pomoč

LAPSy Embedded Academy zvezek v Knjižnica vsebine Projekt-Delo Vsebine TODO VIN Projekt - Ideje VIN Projekti - Done Moduli, Tipala

Skupna raba

PIR Napion Senzor

reda, 31. marec 2021 19:07

AMN22111

MP Motion Sensor (AMN1,2,4)

Panasonic ideas for life

MOTION SENSOR (PASSIVE INFRARED TYPE)

MP MOTION SENSOR 'NaPiOn'

2. Dual lens colors (white and black) are provided
With an ultrasmall design and dual lens colors (white and black), it is inconspicuous, allowing the user to select either white or black to match the equipment color. This provides greater flexibility in equipment design.

3. Both digital output and analog output (with adjustable sensitivity) are available.

4. Built-in amplifier for easy use
Has a built-in amplifier, and can be connected directly to a microcomputer.

• Block diagram of the digital output circuit

6. Noise withstanding capability
Circuitry is contained in a TO5 metal package, providing at least twice the noise withstanding capability as conventional type.

• Comparison example of noise withstanding capability

	Distance at which motion sensor is not affected by cellular phone noise
Conventional type	Min. 1 to 2m 3.281 to 6.562ft
MP Motion Sensor	Min. 1 to 2cm .394 to .787inch

7. A low current consumption type (46 µA) has also been added to the line-up.
A type that keeps current consumption to 46 µA (less than 30% compared to predecessor) is now available. Ideal for battery driven devices.
*Digital output type only.

APPLICATIONS

1. Home appliances
Useful for saving energy in air conditioner, television, personal computer, or ventilator

Standard type Slight motion detection type Spot type 10 m detection type

What is passive infrared type?
This sensor detects changes in infrared radiation which occur when there is movement by a person (or object) which is different in temperature from the surroundings.
① As this sensor detects temperature differences, it is well suited to detecting the motion of people by their

Dodaj stran

Preberi me

VIN Sensors Challenge

- Sharp IR GP2D12
- Effectively Using GP2D12
- Sharp IR GP2Y0A21YK
- HC SR04 UZ Senzor
- Ultrasonic Distance Sensor (HC-SR04)
- Devantech EL Compass
- Devantech SRF04
- LV-MaxSonar-EZ1

PIR Napion Senzor

- MPXV10GC7U Senzor pritiska
- A3144 Hall effect Sensor
- A3144 Hall effect Sensor - Howto
- TPA81 Thermopile Array
- Motion and Gesture Detection by Arduino and PIR Sensor
- Easy Motion and Gesture Detection by PIR Sensor & Arduino
- IR tipalo TPIS 15 1385
- SHT11 Temp./Vlaga
- HR202L - resistivni vlagomer

Tipala za delo

- Tipala kakovosti zraka
- APC1001U_EK
- SEK-SCD41-SENSOR
- Time-of-flight
- 37 in 1 sensor kit for Arduino
- KY-005 in KY-022 IR TX/RX

VIN projekt – Clickboards (STM32H7,F4, Rpi)

Oznaka	Količ.	Namen	Komunikacija	Opis	URL
BEE	2	Zigbee Transc.	GPIO,SPI	MRF24J40 MA	https://www.mikroe.com/bee-click
UV 3	1	I2C UV tipalo	I2C	VEML6070	https://www.mikroe.com/uv-3-click
NFC Tag 4	1	NFC Tag	I2C	16Kb EEPROM	https://www.mikroe.com/nfc-tag-4-click
Light Mix-sense	1	Prox.+color+light sense	I2C	TMD37253	https://www.mikroe.com/blog/light-mix-sens-click https://www.mikroe.com/light-mix-sens-click
BLE 6	2	ST:BLE+BQE Cert.	Analog,GPIO,I2C,SPI,UART	BlueNRG-M2	https://www.mikroe.com/ble-6-click
RS485 5	1	Rs-485 Transc.	UART	MAX485	https://www.mikroe.com/rs485-5-click
Environment 2	2	Temp/Hum/VOC	I2C	SHT40 and SGP40	https://www.mikroe.com/environment-2-click
LightRanger 8	1	ST: Time-Of-Flight	I2C	VL53L3CX	https://www.mikroe.com/lightranger-8-click
Temp&Hum 15	2	Temp.&Humidity	I2C	SHT40,	https://www.mikroe.com/temphum-15-click
Pi Click Shield	2	RPi razširitev			https://www.mikroe.com/pi-click-shield-connectors-soldered
STM32F4 Shield	5	F4 razširitev			https://www.mikroe.com/stm32f4-discovery-click-shield
STM32H750				Direktna priključitev	

[Click Boards \(1290\)](#)

- [Wireless Connectivity \(142\)](#)
- [Sensors \(429\)](#)
- [Interface \(123\)](#)
- [Display & LED \(56\)](#)
- [Miscellaneous \(28\)](#)
- [Mixed Signal \(85\)](#)
- [Storage \(45\)](#)
- [Motor Control \(88\)](#)
- [Audio & Voice \(40\)](#)
- [HMI \(63\)](#)
- [Clock & Timing \(30\)](#)
- [Power Management \(87\)](#)
- [Click Bundles \(17\)](#)
- [Click Shields \(39\)](#)
- [Legacy \(20\)](#)

From <https://www.mikroe.com/click>



VIN projekt - VP1: Uvod, tipala, TinkerCad osnove

- Uvod v VIN projekt
- Tipala
- Spoznavanje TinkerCad-a
- Domača naloga (DN2-VP1)

TinkerCad: izdelajte svoj račun

The screenshot displays the TinkerCad web interface. At the top left is the Autodesk TinkerCad logo. Navigation tabs include 'Tinker', 'Gallery', 'Projects', 'Classrooms', and 'Resources'. A search bar and a user profile icon with '109' are on the top right. On the left sidebar, the user 'rozmanDSF23' is logged in, with a search bar for designs and sections for 'Classes', 'Designs', 'Tutorials', and 'Collections' (including 'VIN LAB'). The main area shows 'Your designs' with a 'Design Challenge: Sim Lab' filter. A grid of 18 design thumbnails is visible, each with a title, date, and privacy status. The designs include breadboard projects, an Arduino project, and various circuit simulations.

Design Title	Time Ago	Privacy
VIN LAB Breadboard ST...	17 days ago	Public
VIN LAB Breadboard De...	17 days ago	Public
Breadboard vezave	17 days ago	Public
Frantic Sango	a month ago	Private
Powerful Kieran	a month ago	Private
Glorious Albar	a month ago	Private
VIN Arduino + SR04 UZ (...)	a month ago	Public
VIN naloga - Rešitev: Ar...	a month ago	Private
Glorious Blorr	2 months ago	Private
Ingenious Blad	a year ago	Private
Frantic Duup	a year ago	Private
Copy of NeoPixel Ring 24...	a year ago	Private
Frantic Blorr-Inari	a year ago	Private
Spectacular Curcan	a year ago	Private
Copy of tinkercad10	a year ago	Private
Test1	a year ago	Private
Copy of 4-bit Latch	a year ago	Private
Copy of 4-bit Adder	a year ago	Private

<https://www.tinkercad.com/>

TinkerCad: the Arduino Simulator you've been looking for!

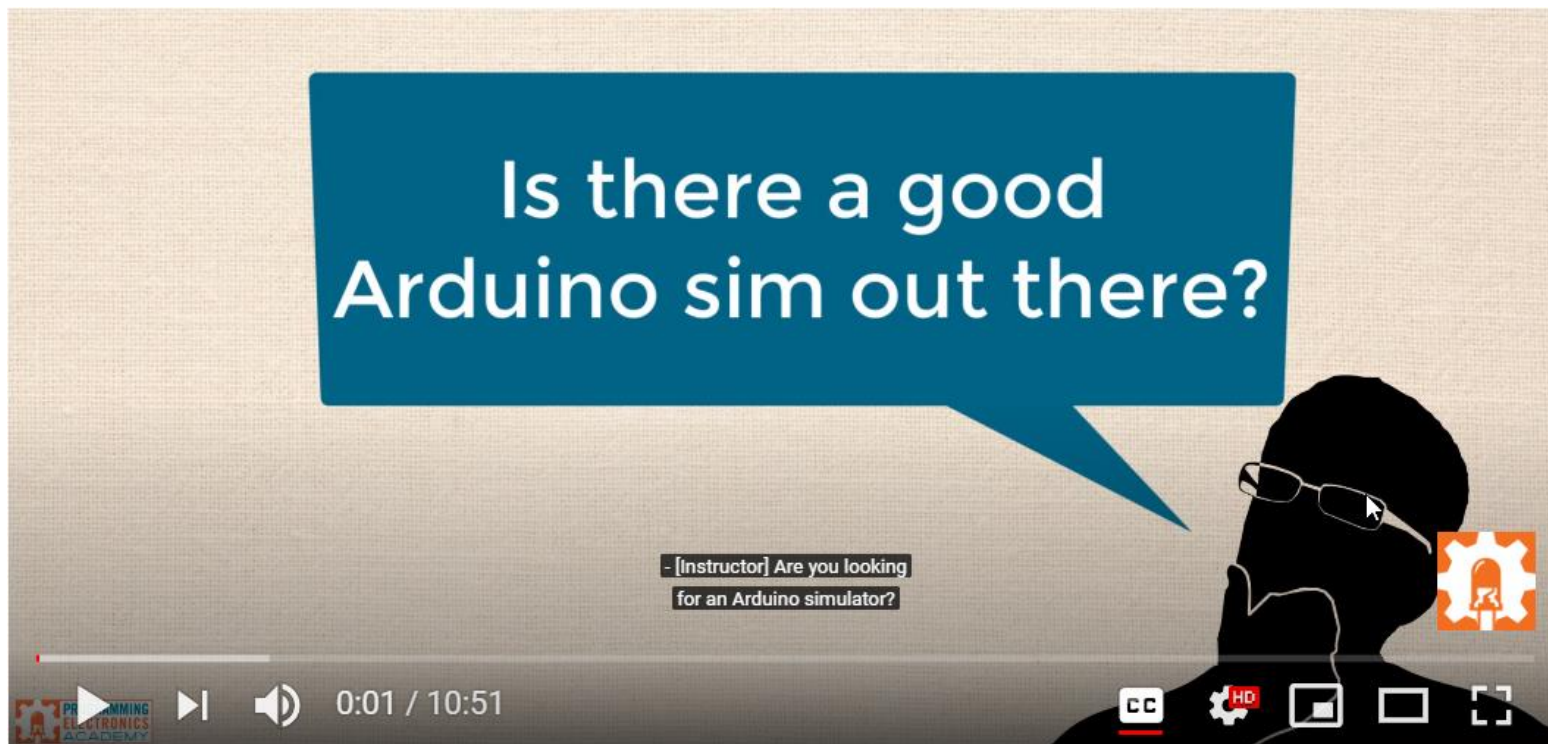

Z naslova <<https://www.youtube.com/watch?v=6uz1sCA9joc>>

Prednosti, slabosti TinkerCad simulacij : Love or hate it? The controversial Arduino Simulator

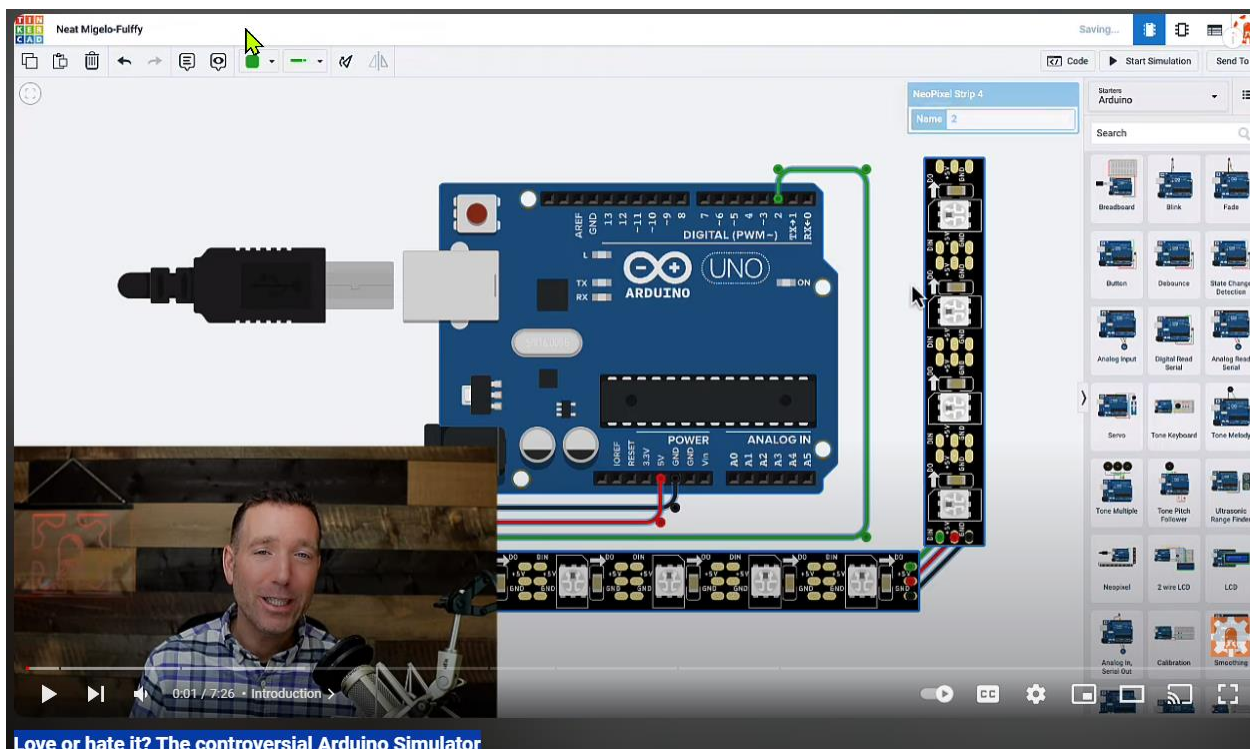

Z naslova <https://www.youtube.com/watch?v=2gHxgwoWPjw&ab_channel=ProgrammingElectronicsAcademy>

TinkerCad – učenje, primeri

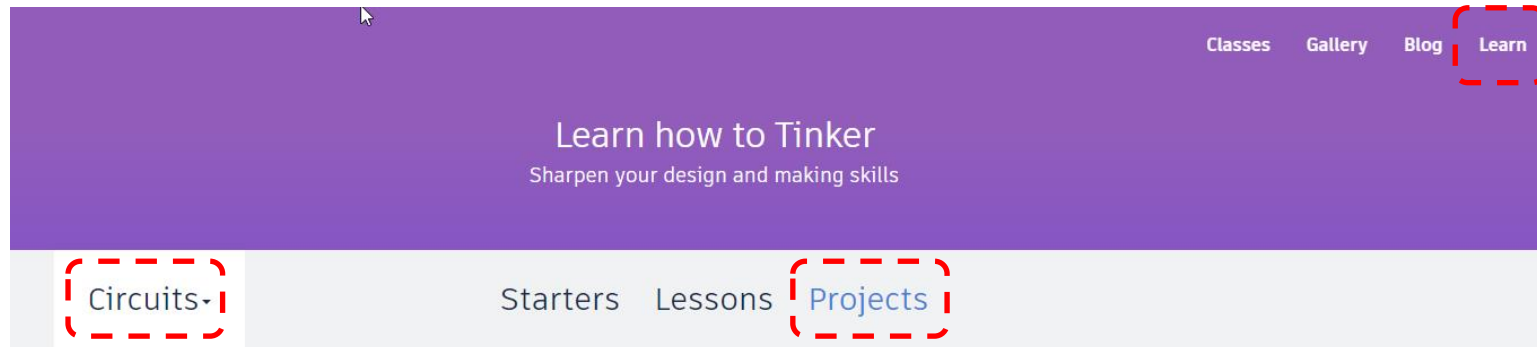

Learn Arduino with our easy-to-follow lessons that set you on the fast path to coding and prototyping your own projects.

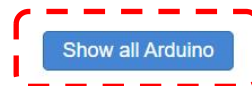
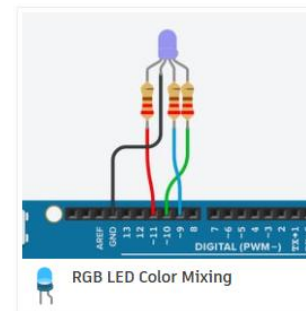
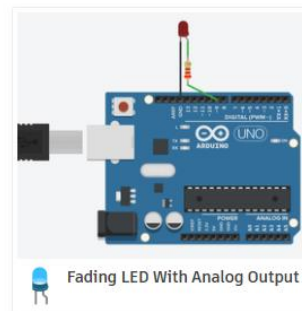
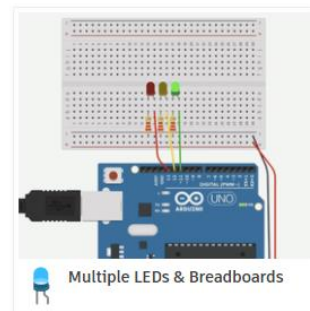
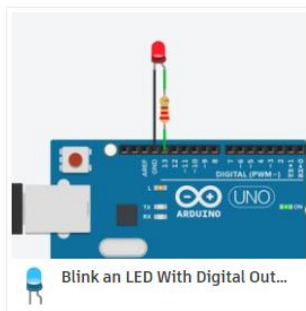

VIN projekt: TinkerCad

Osnovni elementi in preproste vezave

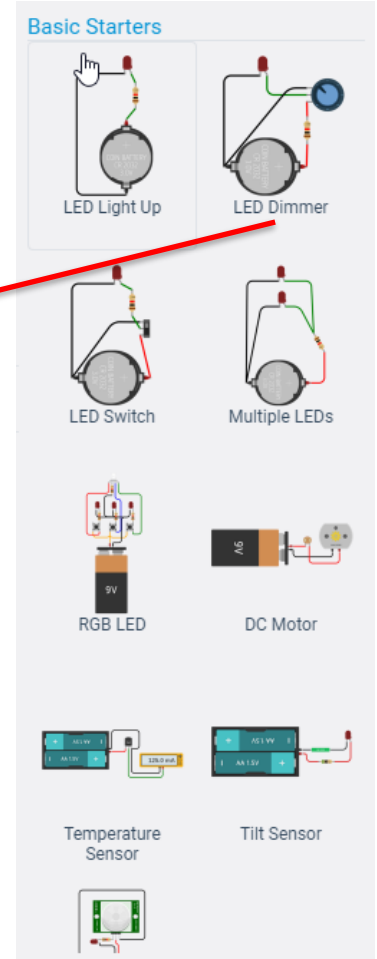
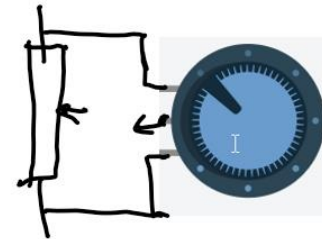
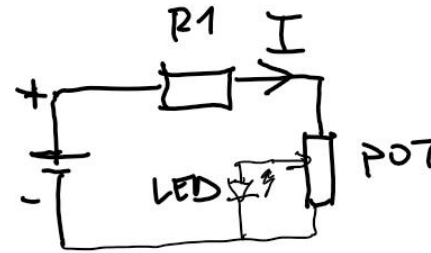
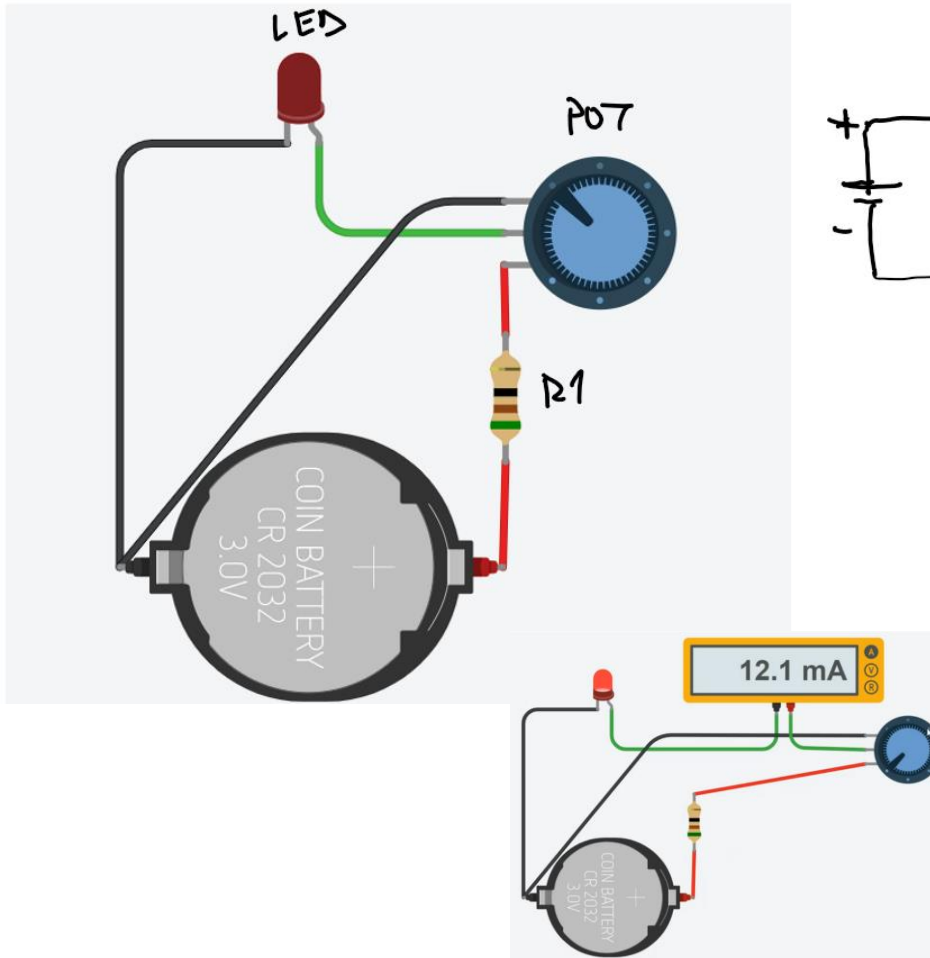

VIN projekt: TinkerCad

Osnovni elementi in preproste vezave

VIN Osnovni elementi in preproste povezave

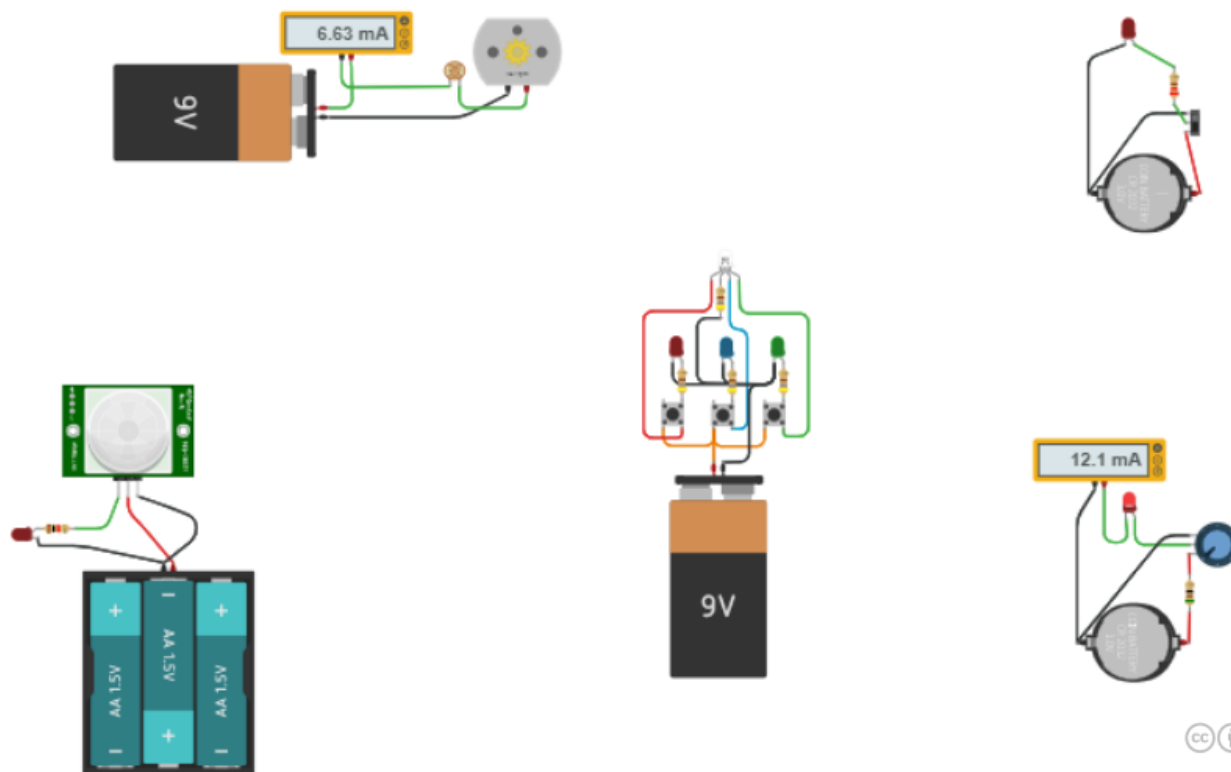

Basic Starters

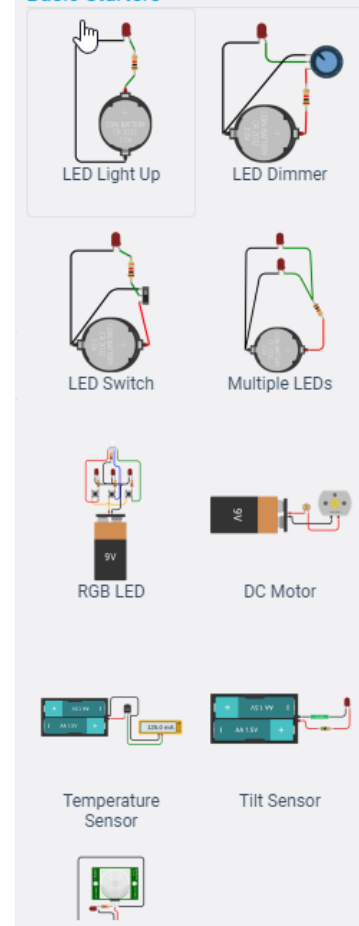

Z naslova <<https://www.tinkercad.com/things/aVrm76VMZSV-vin-osnovni-elementi-in-preproste-povezave>>

VIN projekt : TinkerCad

Uporovna tipala in delilnik napetosti

Uporovna tipala

Z naslova <<https://www.tinkercad.com/things/gRnhGlsvr0z-uporovna-tipala>>

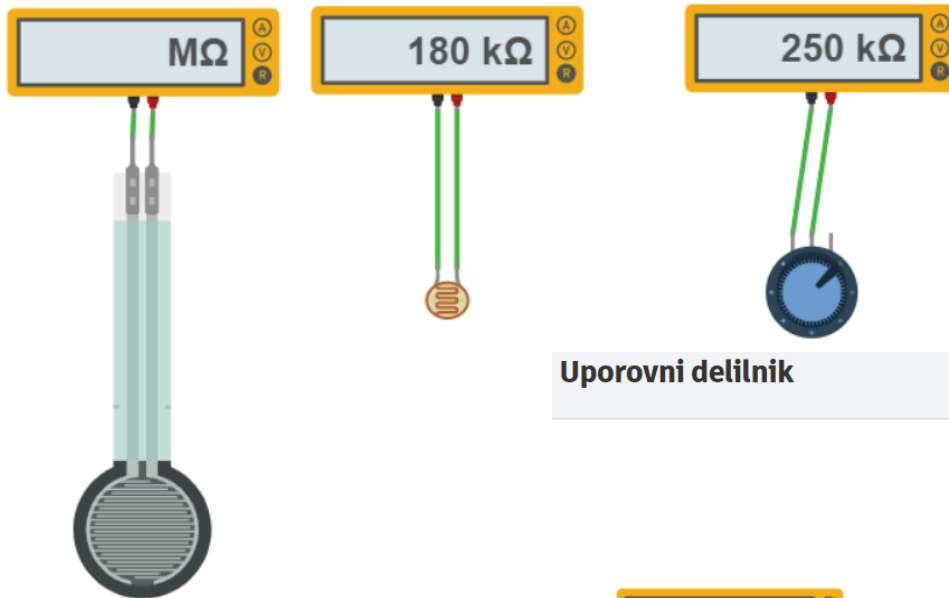

Uporovni delilnik

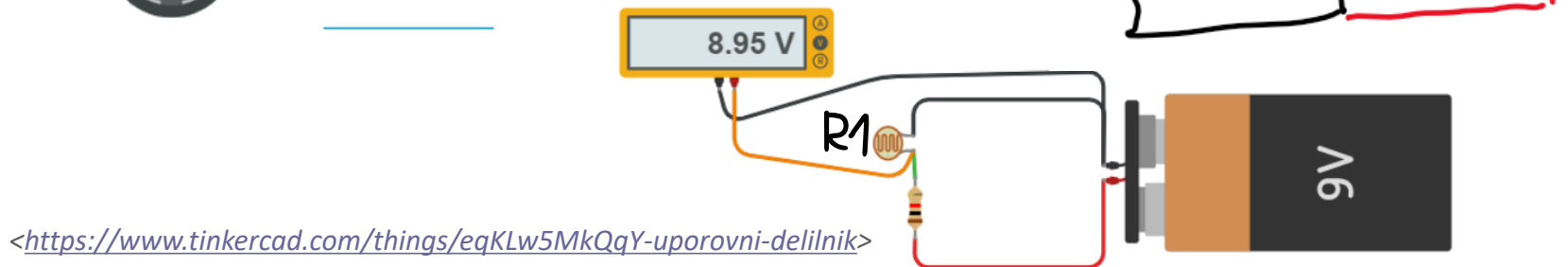

<<https://www.tinkercad.com/things/eqKLw5MkQqY-uporovni-delilnik>>

VIN projekt : TinkerCad

Uporovna tipala in delilnik napetosti

Temperature_sensor_simple_voltage_test

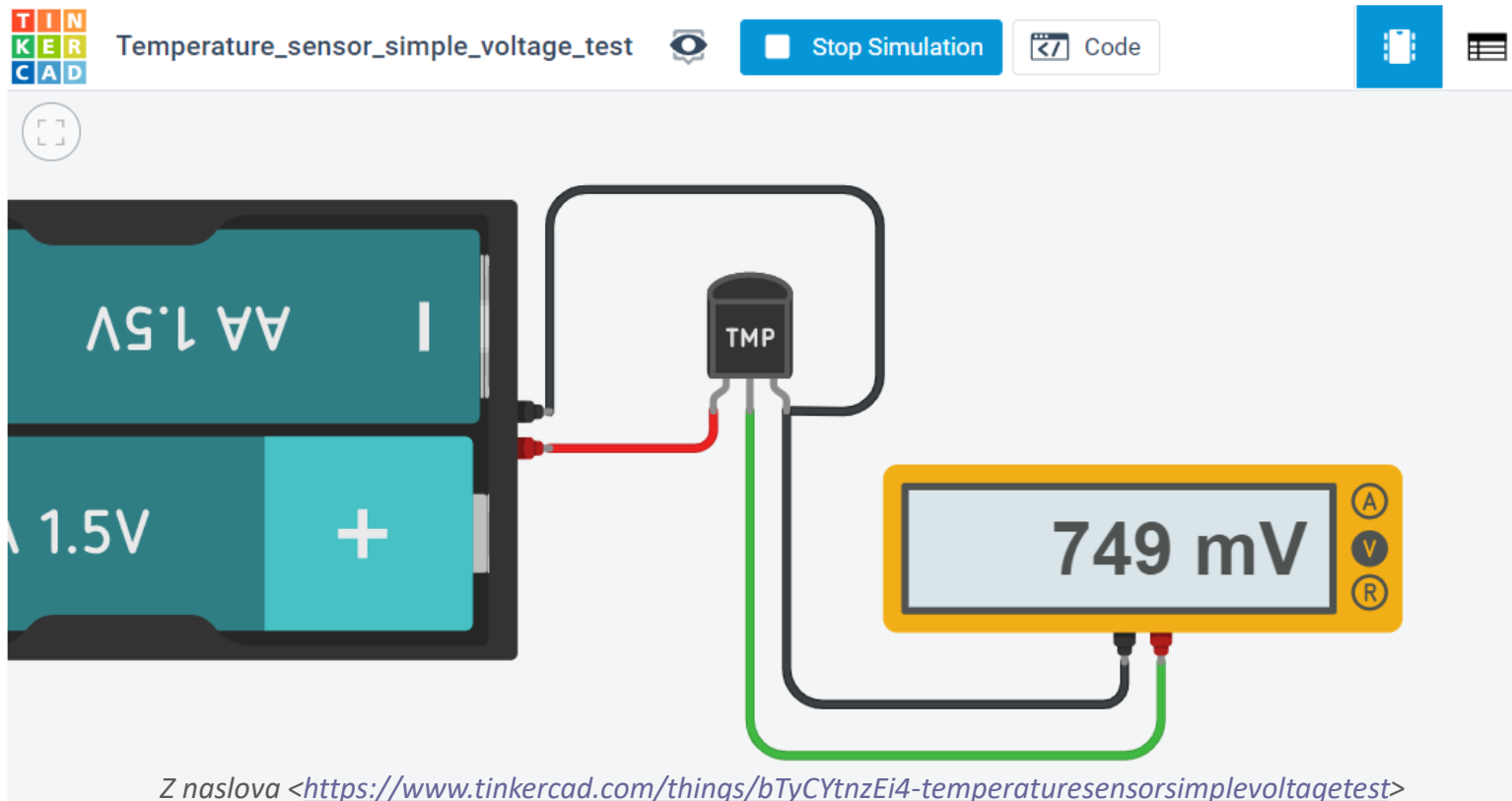

Z naslova <<https://www.tinkercad.com/things/bTyCYtnzEi4-temperaturesensorsimplevoltagetest>>

VIN projekt : TinkerCad

UZ tipalo

UZ Senzor test

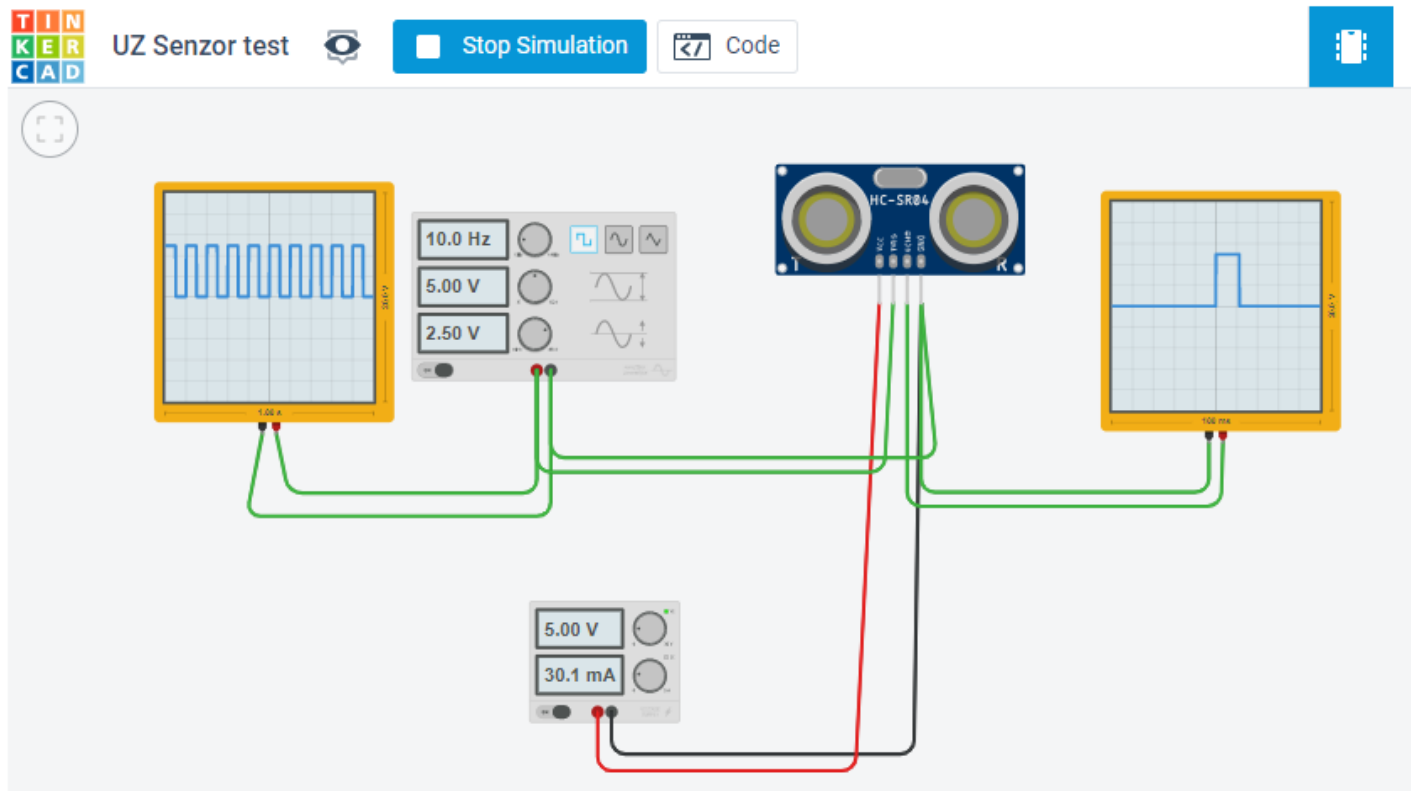

Z naslova <<https://www.tinkercad.com/things/k6it1PauvwW-uz-senzor-test>>

UZ senzor in HC-SR04

LAB Preizkus

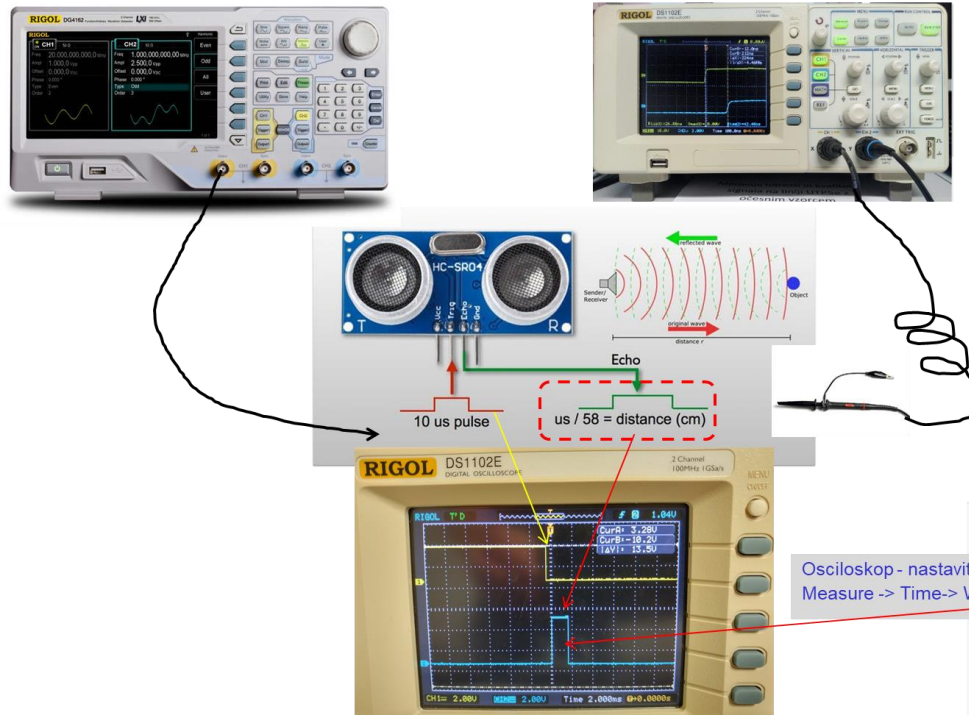

Simulacija - TinkerCad

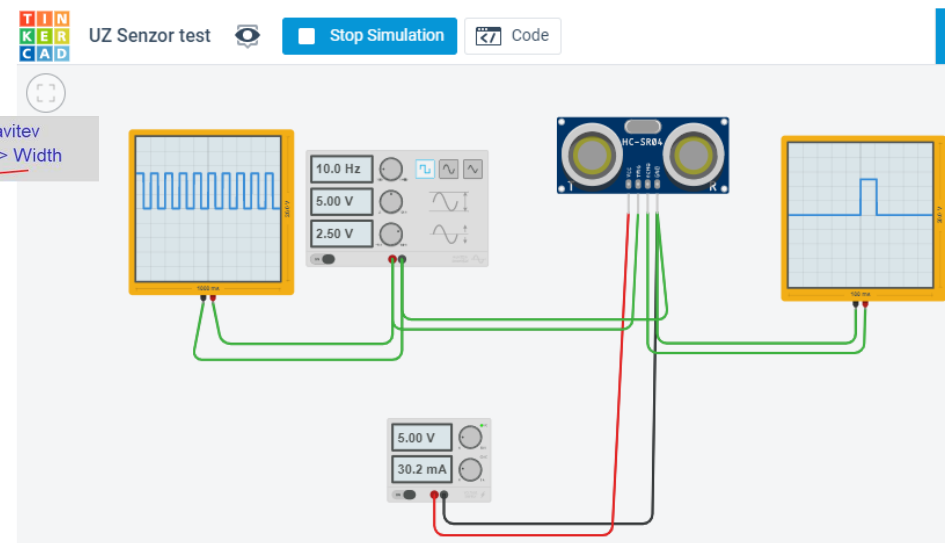

TinkerCad – viri :

■ Learn how to Tinker

- Sharpen your design and making skills
- Circuits
 - [Starters](#)
 - [Lessons](#)
 - [Projects](#)
- From <https://www.tinkercad.com/learn/circuits/learning>

■ Learn how to use Tinkercad to design, build, and test simple circuits.

From <https://maker.pro/custom/tutorial/how-to-design-and-simulate-circuits-in-tinkercad>

■ How to design and simulate circuits using Tinkercad | Beginner Level

From <https://fullyelectronics.com/how-to-design-and-simulate-circuits-using-tinkercad-beginner-level/>

■ [Electronic Circuit Basics with TinkerCAD 2 \(energiazero.org\)](https://energiazero.org)

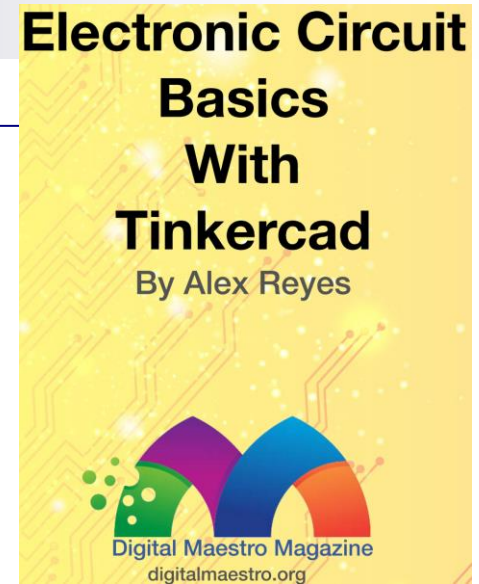

VIN projekt - VP1: Uvod, tipala, TinkerCad osnove

- Uvod v VIN projekt
- Tipala
- Spoznavanje TinkerCad-a
- Domača naloga (DN2-VP1)

VP1: TinkerCad in osnovne vezave

TinkerCad – DN2-VP1 :

- Spada v sklop poročila z LAB vaj (DN2)
- Naredite sebi zanimivo osnovno vezje(a),
 - še brez uporabe mikrokrmilnika (Arduino)
- Objavite v OneNote delovnem zvezku
 - Prostor za sodelovanje, razdelek DN2-VP1 TinkerCad_Osнова

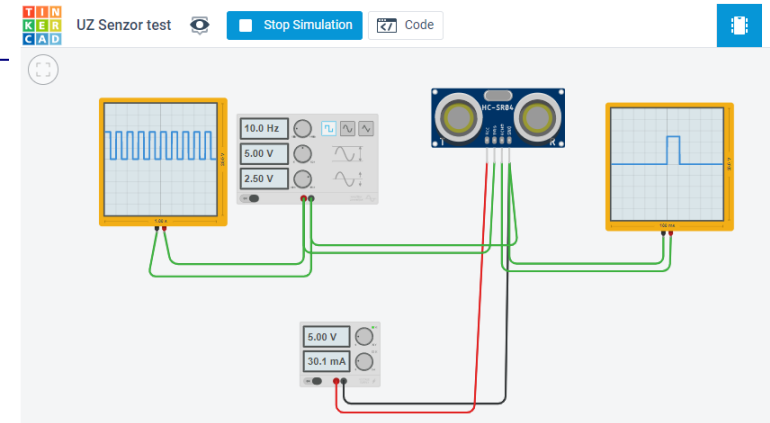

OneNote za Windows 10

Osnovno Vstavlanje Risanje Ogled Pomoč Zvezek za predavanja

Calibri Light 20 K L P A

VIN-VSP 202324 zvezek

Dobrodošli Preberi.me

_Collaboration Space

Uporaba prostora za sodel...

DN1-VI naprave

DN2-VP1 TinkerCad

DN2-VP2 TinkerCad+ARD

VIN Projekt-Viri

VIN Projekt-Ideje

Preberi.me

sreda, 16. marec 2022 18:09

Tukaj objavite svoje rešitve naloge:

- Naredite svojo stran z naslovom rešitve
- Par stavkov opisa, slika in povezava na [TinkerCad](#) vezje
- Rešitev shranite v svojem zvezku za vključitev v DN2 poročilo z laboratorijskih vaj

TinkerCad – DN2-VP1: Primer zapisa (objave)

Preprosto vezje za preizkus delovanja UZ tipala razdalje

Sestavni deli:

- Napajalnik skrbi za napajanje tipala
- Generator pravokotnega signala proži Trigger vhod tipala, da sproži oddajo UZ signala
- Osciloskop prikaže izhod tipala, ki s širino pulza ponazarja oddaljenost objekta oziroma čas potovanja signala do objekta in nazaj

Opis delovanja:

Interaktivno se lahko z miško spreminja pozicija oziroma oddaljenost objekta, kar se odrazi na širini impulza na izhodu UZ tipala (osciloskop).

UZ Sensor test

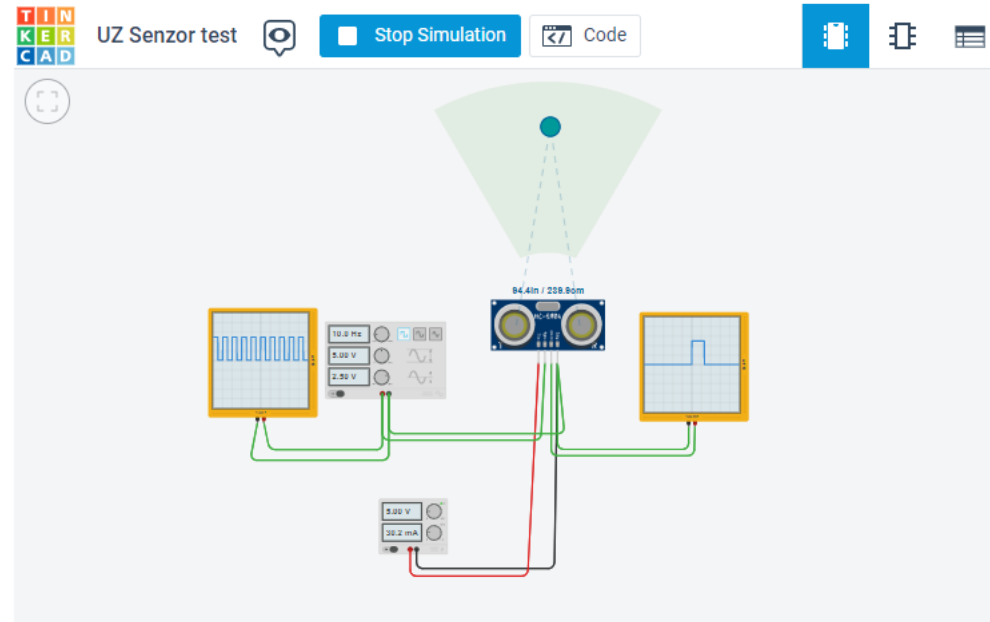

<https://www.tinkercad.com/things/k6it1PauvWw>